



OPERATING INSTRUCTIONS
MIG/MAG impulse welding systems

FOCUS.ARC P
MEGA.ARC P AND S

REHM SCHWEISSTECHNIK



Operating instructions

Name MIG/MAG impulse welding systems

Type

FOCUS.ARC P 300 -W; -S; -WS
FOCUS.ARC P 350 -W; -S; -WS
FOCUS.ARC P 400 -W; -S; -WS
FOCUS.ARC P 450 -W; -S; -WS

MEGA.ARC P/S 300 -W; -S; -WS
MEGA.ARC P/S 350 -W; -S; -WS
MEGA.ARC P/S 400 -W; -S; -WS
MEGA.ARC P/S 450 -W; -S; -WS

Manufacturer **REHM GmbH u. Co. KG**
Ottostr. 2
D-73066 Uhingen

Telephone: 07161/3007-0
Telefax: 07161/3007-20
E-Mail: rehm@rehm-online.de
Internet: <http://www.rehm-online.de>

Document No.: 7302600

Date of issue: 05/05/2022

© REHM GmbH u. Co. KG, Uhingen, Germany 2022

The content of this description is the property of REHM GmbH u. Co. KG
The copying and distribution of this document, its use and communication of its contents are strictly prohibited unless expressly authorized.

Offenders are liable to damages. All rights reserved in the event of patent, utility model or design patent.

The manufacture based on these documents is not allowed.

Subject to change.

List of contents

1	INTRODUCTION.....	6
1.1	Foreword.....	6
1.2	General description	7
1.2.1	The principle of the inert gas metal welding process.....	8
1.2.2	Intended use	8
1.3	Symbols used.....	9
2	SAFETY INSTRUCTIONS.....	10
2.1	Warning symbols in these operating instructions	10
2.2	Warning symbols on the system.....	10
2.3	Notes and requirements	11
3	UNIT DESCRIPTION	13
4	FUNCTIONAL DESCRIPTION	20
4.1	Overview of the operating elements	20
4.2	Control panel description.....	21
4.2.1	Operating elements.....	21
4.2.2	Operating elements.....	22
4.3	Switching on.....	25
4.4	Peculiarities of the operating panel	25
5	CORNER MENU FUNCTIONS.....	26
5.1	Corner menu welding processes (top left).....	26
5.1.1	GMAW.....	26
5.1.2	GMAW manual.....	26
5.2	Corner menu operating mode (top right).....	27
5.2.1	2 cycle operating mode.....	27
5.2.2	2 cycle operating mode with slope-down (Slope)	29
5.2.3	4 cycle operating mode.....	30
5.2.4	4 cycle operating mode with slope-down (Slope)	31
5.2.5	Spot.....	32
5.2.6	Spot with slope-down (Slope)	33
5.2.7	2 cycle interval	34
5.2.8	2 cycle interval with slope-down (Slope).....	35
5.2.9	4 cycle interval with Hot-start	36
	4 cycle interval operating mode procedure with Hot-start.....	36
5.2.10	4 cycle interval with slope-down (Slope).....	37
	4 cycle interval operating mode procedure with slope-down (Slope).....	37
5.3	Corner menu characteristic curve.....	38
5.4	Corner menu welding process	38
5.4.1	FOCUS.ARC	38
5.4.2	FOCUS.PULS	38
5.4.3	FOCUS.ROOT	39
5.4.1	POWER.ARC (GMAW).....	39
5.4.2	POWER.PULS	39
5.5	Display panel Welding current (A)	40

5.6	Display panel Voltage (V)	40
5.7	Display panel Dynamic correction (SDI)	40
5.8	Display panel LBL correction	40
5.9	Display panel Material thickness	40
5.10	Display panel Wire feed speed	40
5.11	Characteristic curve info bar	40
6.	SUBMENUS	41
6.1	GMAW-Parameters	41
6.1.1	Parameter settings	41
6.1.2	Setting the GMAW welding parameters	41
6.1.3	Explanation of welding parameters	43
6.2	Language menu	45
6.3	Saving and loading jobs	46
6.3.1	Save job	46
6.3.2	Load job	48
6.3.3	Edit jobs and folders	50
6.4	Setup submenu	52
6.5	Welding Circuit: Detect	55
7	CONTROL LAMPS	56
8.1	Threading	57
8.2	Gas test	57
8.3	Water recirculation cooling	57
8.4	Temperature monitoring of the power units	57
8.5	External cooling of the power units	58
8.6	Fan and water pump control	58
8.7	Polarity selection for self-shielded cored wires	58
9	ACCESSORIES AND OPTIONS	59
9.1	Unit versions, accessories and options	59
10	COMMISSIONING	63
10.1	Safety instructions	63
10.2	Working under elevated electrical risk in accordance with the regulations from IEC 974, EN 60 974-1, TRBS 2131 and BGR 500 Section 2.26 (previously VGB 15) (S)	63
10.3	Positioning the welding unit	63
10.4	Connecting the welding unit	64
10.5	Cooling the welding unit	64
10.6	Water cooling for MIG/MAG welding torches	64
10.7	Connecting the welding cables	64
10.8	Connecting the torch	65
10.9	Inserting the wire	65
11	OPERATION	66

List of contents

11.1	Safety instructions	66
11.2	Checks before switching on	66
11.3	Connecting the grounding cable	66
11.4	Practical instructions for use	66
12	FAULT.....	69
12.1	Safety instructions	69
12.2	Table of faults	69
12.3	Error messages	71
13	MAINTENANCE AND REPAIR	72
13.1	Safety instructions	72
13.2	Maintenance table	73
13.3	Cleaning the inside of the unit.....	73
13.4	Cooling water check	74
13.5	Proper disposal	74
14	CIRCUIT DIAGRAMS	75
14.1	Characteristic curve current source	78
15	COMPONENTS AND SPARE PARTS.....	80
15.1	Characteristic curve wire feeding unit.....	80
16	TECHNICAL DATA	85
17	INDEX	86

1 Introduction

1.1 Foreword

Dear Customer,

You have purchased a REHM inert gas welding system, a renowned German brand name.

We thank you for the confidence you have placed in our quality products.

Only components of the highest quality are used in FOCUS.ARC P/S and MEGA.ARC P/S welding systems.

To enable a long service life even under the toughest conditions all REHM equipment is manufactured using only parts that comply with our strict quality demands.

The FOCUS.ARC P/S and MEGA.ARC P/S has been developed and designed according to the generally accepted rules of technology and safe operation. All relevant legal regulations have been observed and complied with. Conformity is declared and is marked with the CE symbol.

REHM welding systems are manufactured in Germany and therefore bear the "Made in Germany" quality label.

REHM strives to immediately take advantage of technical progress and reserves the right to adapt the design of the welding equipment at any time to the latest technical requirements.

1.2 General description



Figure 1: FOCUS.ARC P450 WS
(Figure does not illustrate standard equipment)

1.2.1 The principle of the inert gas metal welding process

With the inert gas metal welding process an electric arc burns between a melting wire electrode and the workpiece. Argon, carbon dioxide (CO₂) or a mixture of these or other inert gasses are used.

The positive pole usually flows from the current contact tips to the wire electrode and the negative pole is connected to the workpiece. An electric arc forms between the wire electrode and the workpiece that melts both the wire electrode and the workpiece. The wire electrode is therefore the conductor for the arc and weld filler material.

The wire electrode and the weld pool are protected against the influence of ambient air by the inert gas, which flows continuously from the inert gas nozzle that is arranged concentrically around the electrode.

1.2.2 Intended use

FOCUS.ARC P/S and MEGA.ARC P/S welding systems may only be used for MIG/MAG welding.

REHM welding units are designed for welding various different metallic materials such as unalloyed and alloyed steels, stainless steels, aluminium and CuSi3. Please also observe the special rules that apply to your applications.

REHM welding machines are designed for use in both hand-held and machine-guided operation.

REHM welding machines are, except when this is expressly stated in writing by REHM, only for sale to commercial / industrial users and are only intended to be used by commercial / industrial users. The machines may only be operated by persons who trained in the use and maintenance of welding equipment.

Welding power sources may not be installed in areas with increased electrical risk.

This manual contains rules and guidelines for the intended use of your system. Only compliance with these guidelines shall be considered as proper use. Risks and damages incurred due to any other use is the responsibility of the operator. Use under special requirements may necessitate the observance of particular regulations.

If in doubt, ask your competent safety officer or contact the REHM customer service department.

The special instructions listed in the supplier documentation for intended use must be observed.

National regulations also apply without restriction to the operation of the system.

Welding power sources may not be used to defrost pipes.

Intended use also includes compliance with the prescribed assembly, disassembly and reassembly, commissioning, use, maintenance and disposal measures. Please pay particular attention to the information in Section 2 Safety instructions and Section 15.5 Proper disposal.

The system may only be operated under the aforementioned conditions. Any other use is considered unintended use. The consequences of unintended use rests with the operator. Welding power sources may not be used to defrost pipes.

1.3 Symbols used

Typographic distinctions

- Enumerations preceded by a bullet point: General enumerations
- Enumerations preceded by a square: Work or maintenance steps that must be performed in the order listed.

→ Section 2.2, Warning symbols on the system

Cross section: here to Section 2.2, Warning symbols on the system

Bold text is used for emphasis

Note!

... indicates practical tips and other particularly useful information.



Safety symbols

The safety symbols used in this manual: → Section 2.1

2 Safety instructions

2.1 Warning symbols in these operating instructions

Warnings and symbols

This or a symbol that more accurately specifies the risk can be found in all of the safety instructions given in these operating instructions where there is danger to life and limb.

One of the signal words below (Danger!, Warning!, Caution!) is used to indicate the severity of the risk:



Danger! ...warning of immediate danger.

Death or serious injury may result if the warning is not heeded.

Warning! ... of a potentially dangerous situation.

Death or serious injury may result if the warning is not heeded.

Caution! ... warns of a potentially harmful situation.

Slight or minor injuries or property damage may result if the warning is not heeded.

Important!



Notice of a potentially harmful situation. The product or an object in the vicinity may be damaged if the warning is not heeded.



Materials that are hazardous to health or the environment. Materials/operating materials that must be handled or disposed of in a legally conformant way.

2.2 Warning symbols on the system

identify hazards and hazard sources on the system.



Danger!

Risk of electrical shock!

Non-observance may result in death or injury.

2.3 Notes and requirements

Hazards of non-compliance



The system was developed and designed by the generally accepted rules of technology.

Nevertheless, residual dangers to the life and limb of the operator or the risk of damage to the system or other property may still arise in the use of the system.

Safety equipment must never be dismantled or put out of operation as this will result in dangerous hazards and the intended use of the system is no longer guaranteed. The dismantling of safety devices for equipping, repairing and maintenance is described in detail. The safety devices must be refitted immediately on completion of such work.

When using external aids and agents (for example, solvents for cleaning) the user of the system is responsible for ensuring the safety of the unit.

All safety instructions and warnings and the nameplate on / near the system must be kept visible and legible.

Safety information



The occupational safety and health regulations serve as safety references. They must be observed.

In addition to the safety instructions listed in this section, the safety instructions contained in the current text must also be observed.

Beside the advice given in these operating instructions, the general safety and accident prevention regulations (in Germany, among others UVV BGV A3, TRBS 2131 and BGR 500 Chapter 2:26 (previously VGB 15): "Welding, cutting and allied processes" and particularly the conditions for arc welding and cutting contained therein or the corresponding national regulations) must be observed.

Also observe the safety information signs on the factory floor of the operator.

Applications



REHM welding machines are, except when this is expressly stated in writing by REHM, only for sale to commercial / industrial users and are only intended to be used by commercial / industrial users.

The FOCUS.ARC P/S and MEGA.ARC P/S MIG/MAG gas welding equipment are designed in accordance with EN 60974-1 Arc welding equipment - welding power sources for overvoltage category III and pollution degree 3 and in accordance with EN 60974-10 Arc welding equipment - electromagnetic compatibility (EMC) and may only be used on mains supply systems which have a three-phase four-wire system with earthed neutral conductor.

FOCUS.ARC P inert gas welding systems may only be used

- as intended
- in an absolutely perfect condition

Dangerous nature of this machine

The FOCUS.ARC P MIG/MAG gas welding equipment has been subjected to a safety test and acceptance. In the event of incorrect operation or misuse, there is a danger to

- life and limb of the operator,
- the machine and other material assets of the operator
- the efficient work of the machine

All persons involved in the installation, commissioning, operation, maintenance and repair of the machine must

- be appropriately qualified
- strictly observe these operating instructions.

Your safety is at stake!

Qualification of the operating personnel

FOCUS.ARC P/S and MEGA.ARC P/S MIG/MAG gas welding equipment should be operated only by persons who are trained and instructed in the use and maintenance of welding equipment. Only qualified, assigned and trained personnel may work on and with the system.

The operator is responsible for third parties in the work area. The responsibility for this machine must be precisely defined and adhered to. Unclear responsibilities are a safety risk.

The operating company must

- make the operating instructions accessible to the operator and
- ensure that the operator has read and understood them.

Connect a lockable switch in front of the machine to prevent unauthorised operation.

Purpose of the document

These operating instructions contain important information on how this unit can be operated safely, properly and economically. A copy of the operating instructions must be constantly at hand in a suitable place at the site of use of the system. Before using the system be sure to read the information compiled in these operating instructions. These include important instructions on use of the equipment that enable the full technical advantages of the REHM equipment to be exploited. See also the information on repair and maintenance, operating safety and functional reliability.



These operating instructions are not a substitute for the practical teaching by the REHM service personnel.

Documentation for any additional operation that may be present must also be observed.

Changes to the system

Changes to the system or the mounting or incorporation of additional equipment is not permitted. Doing so will invalidate any warranty and liability claims.

Third-party intervention and putting out of operation of safety devices invalidates all warranty claims.

Requirements on the mains supply

High power units can affect the mains voltage due to their high power consumption. Therefore, connection restrictions, requirements for a maximum permissible mains impedance or requirements for a minimum necessary available power at the connection point to the general mains supply may exist for certain unit types (see technical data). If this is the case, the user of a unit - after consulting the power supplier if necessary - must ensure that the unit may be connected.

3 Unit description

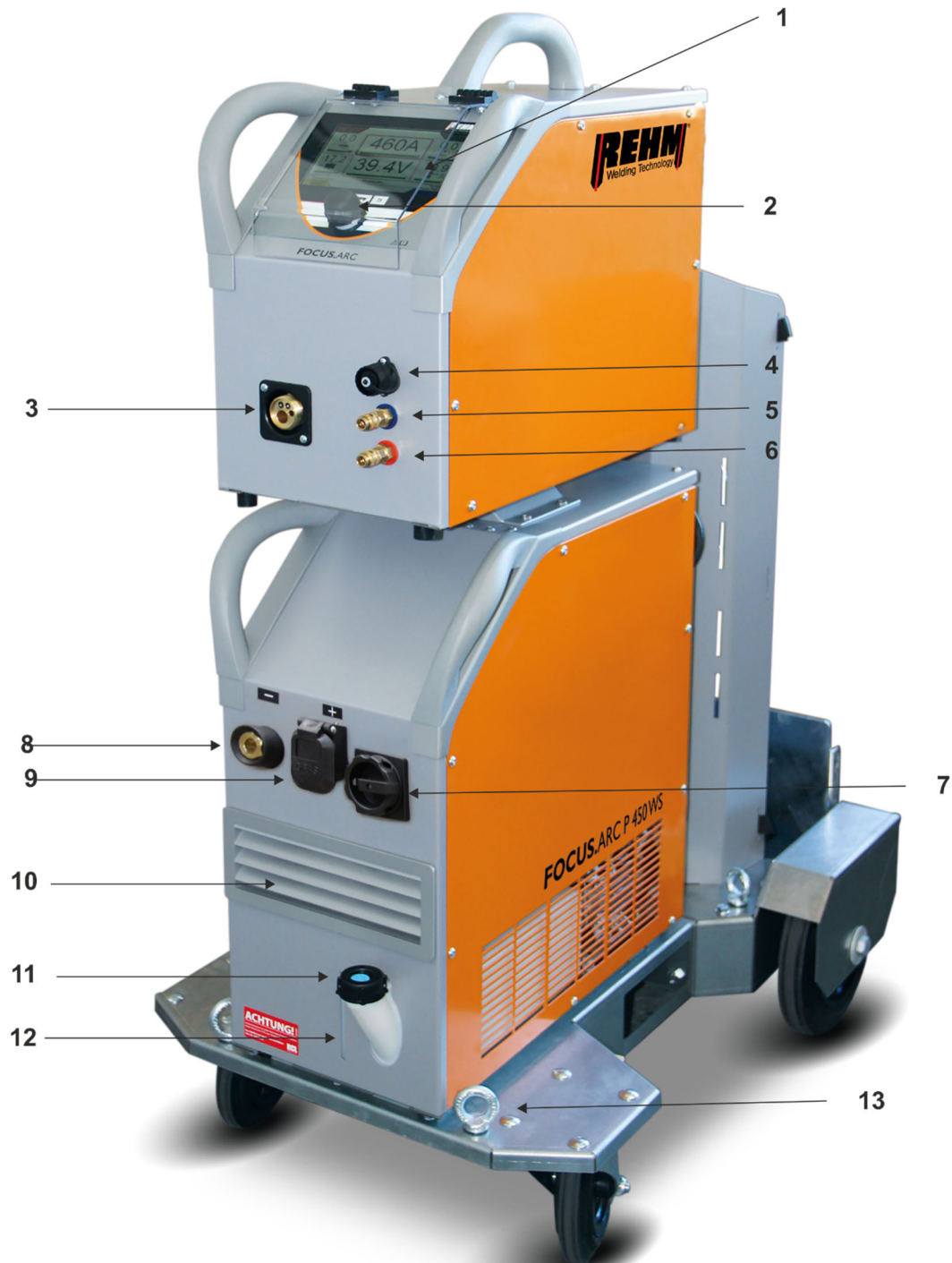

Figure 2: FOCUS.ARC P 450WS with case and water cooling unit
Front view (Figure does not illustrate standard equipment)



Figure 3: FOCUS.ARC P 300W, compact and water cooled
Front view (Figure does not illustrate standard equipment)

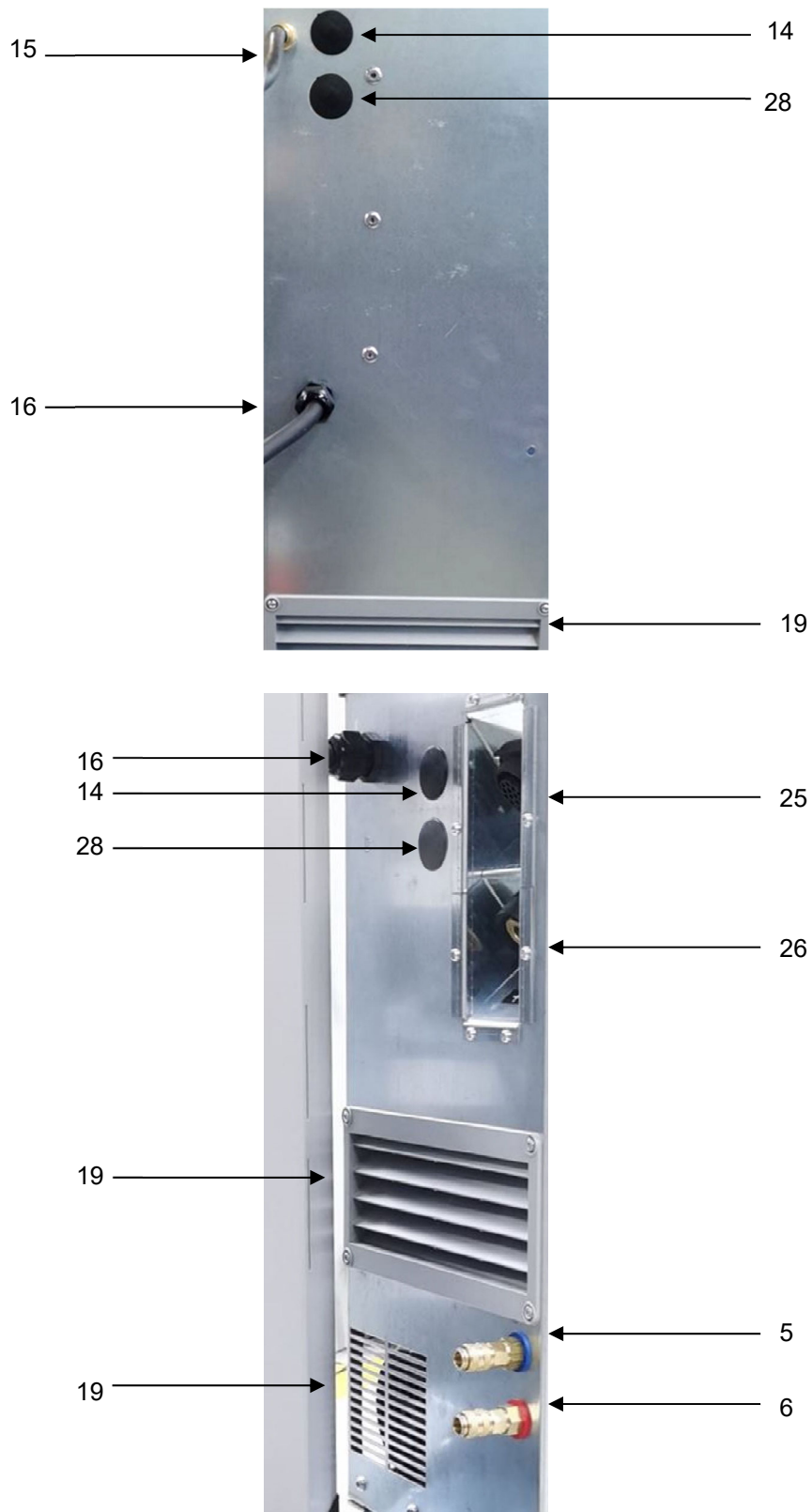
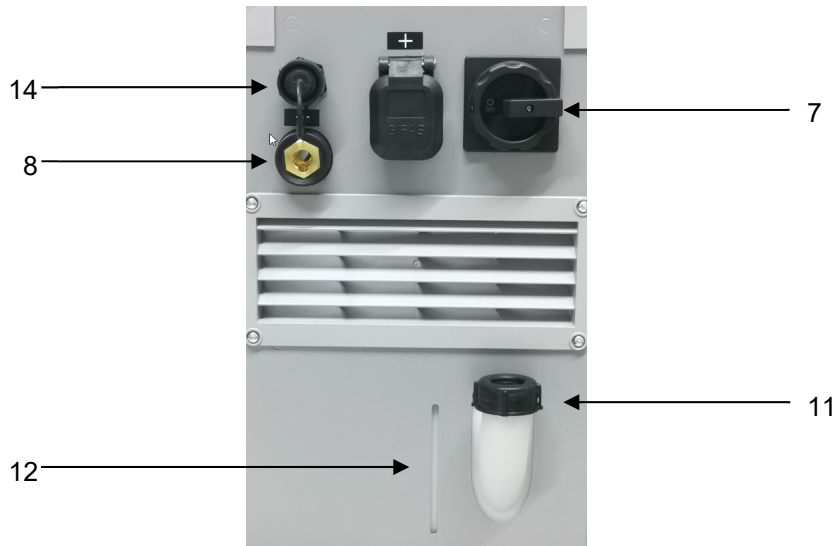
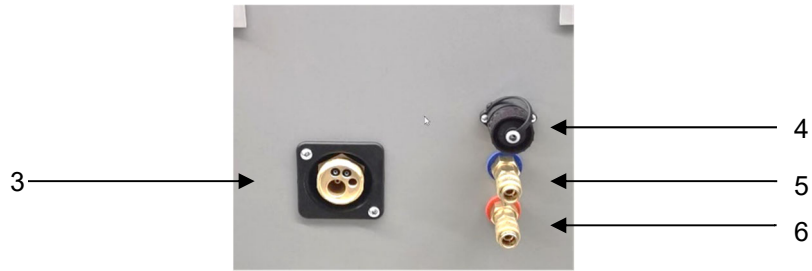

Figure 4: FOCUS.ARC P 450
Rear view of different design variants (Figure does not illustrate standard equipment)



*Figure 5: FOCUS.ARC P 450 (wire feed case unit)
Front view with separate feed case
(Figures does not illustrate standard equipment)*

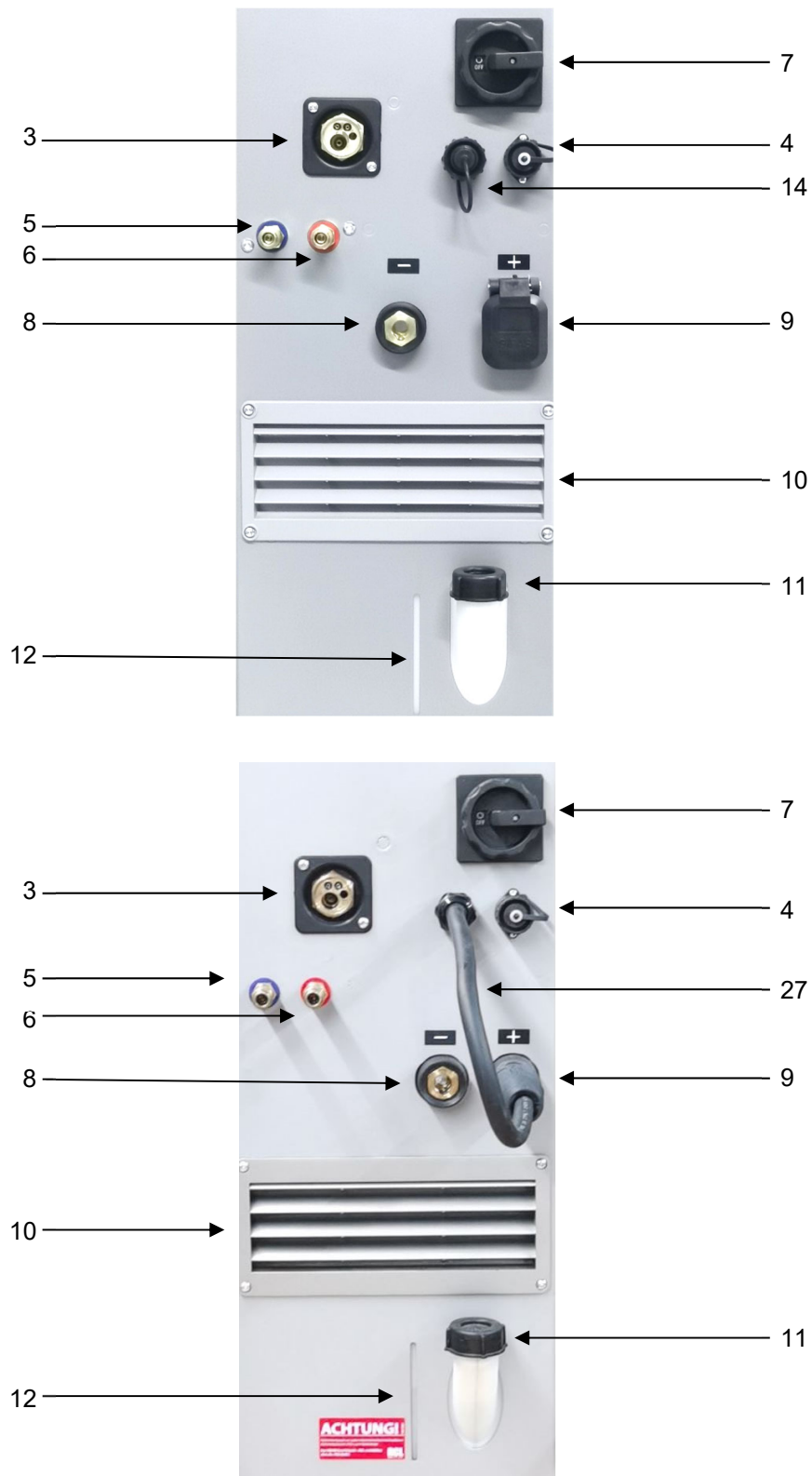

Figure 6: FOCUS.ARC P 450 (compact unit)
 Front view of different design variants (Figures does not illustrate standard equipment)

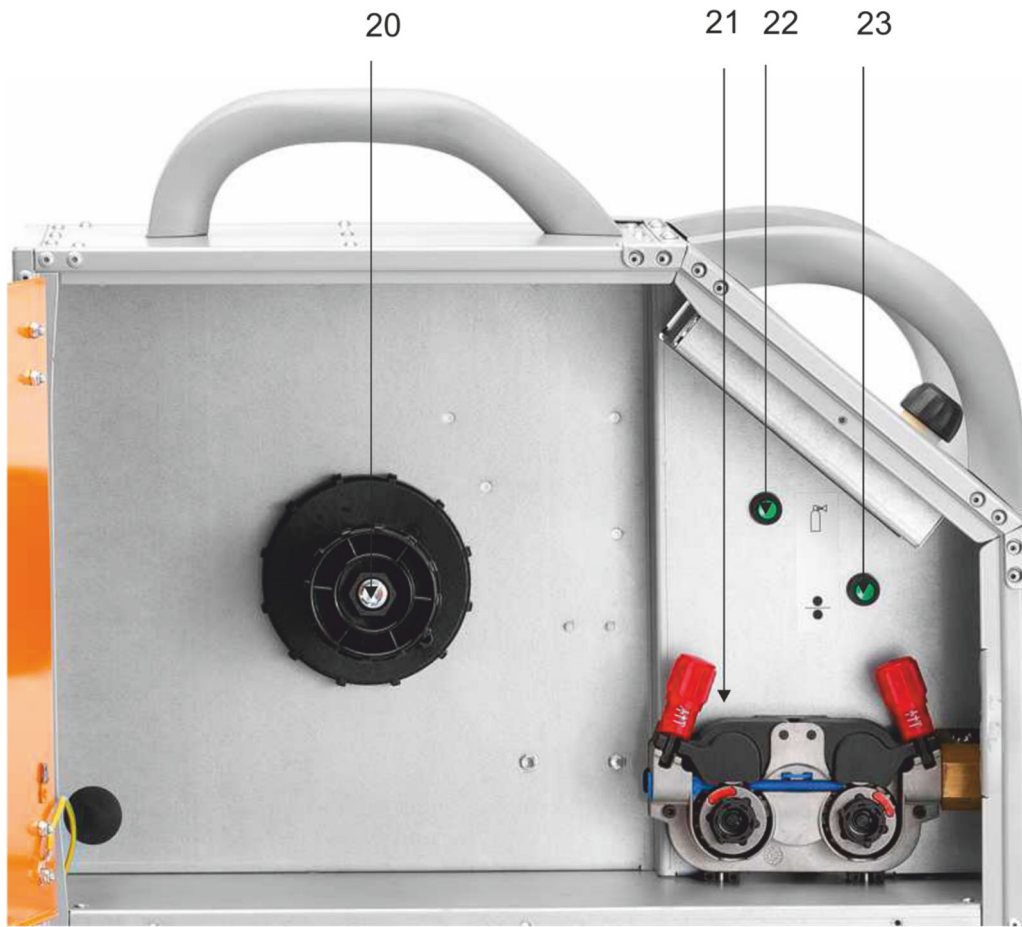

Figure 7: FOCUS.ARC P wire feed case

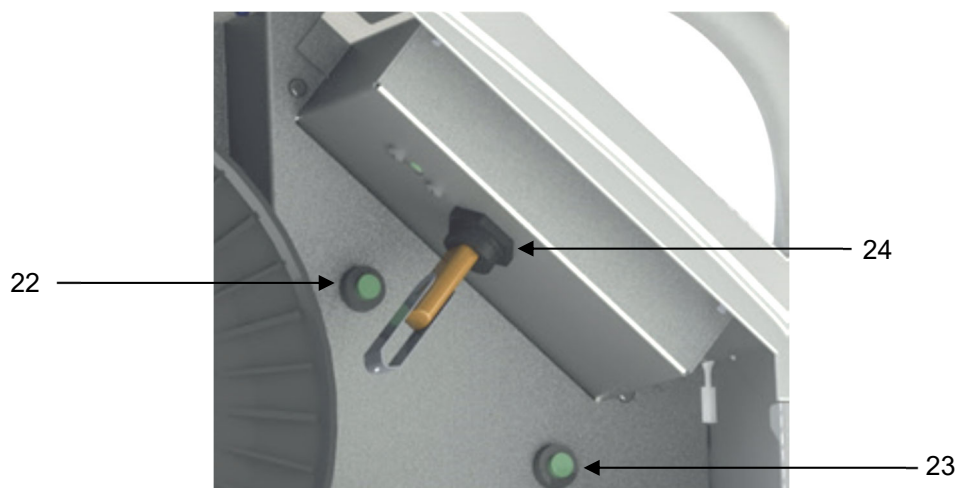

Figure 7: FOCUS.ARC P back of the Control panel

Function description





No.	Symbol	Function / description
1		Control panel - See "Description of controls"
2		Control panel push and rotary encoder
3		Welding torch connection (Euro connection)
4		Remote control socket (7 pin)
5		Connection coolant supply (Blue)
6		Connection coolant return (red)
7		Main switch for switching on/off the welding current source
8		Current socket "negative"
9		Current socket "positive"
10		Cooling air inlet
11		Inlet Filling Coolant Water cooling unit
12		Viewing window Stand Coolant Water cooling unit
13		Advanced trolley (option, non-standard)
14		Interface CAN (option) Exclusively for connecting external BDE or other CAN devices. Not for Ethernet!
15		Inert gas connection Welding torch
16		Power cable
17		Welding power sources
18		Water cooling unit (Option)
19		Cooling air outlet
20		Coil mandrel
21		Wire feeding unit
22		Gas test push button
23		Threading push button
24		USB port
25		Intermediate hose package – control line connection
26		Intermediate hose package - Welding current cable connection
27		Polarity selection plug for torch connection
28		Interface (option) for connection to Ethernet

Table 1 Equipment labelling on the front and back

4 Functional description

4.1 Overview of the operating elements

MEGA.ARC P/S

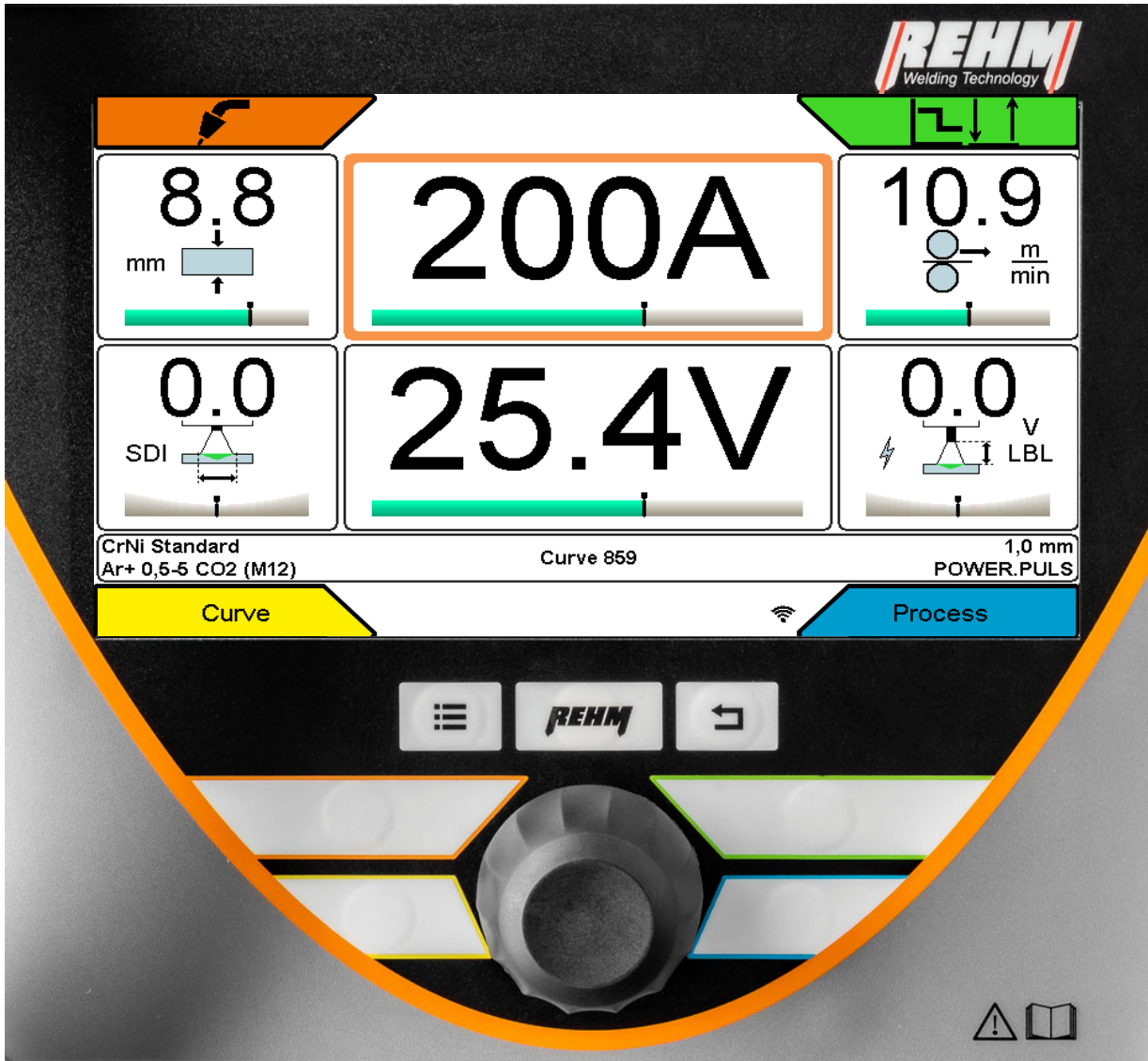
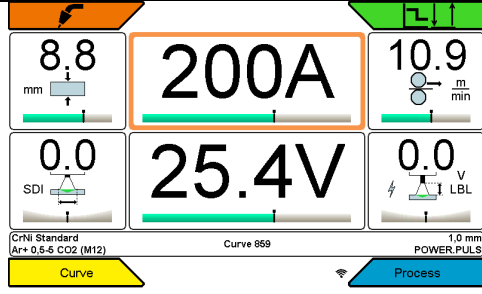





Figure 9: Operating element and main screen FOCUS.ARC P

4.2 Control panel description

4.2.1 Operating elements

Controls	Function									
 <p><i>Fig. 10 Main screen</i></p>	<p>Main screen</p> <p>Operation via rotary encoder with push-knob and buttons for menu selection in the 4 corners of the screen</p>									
 <p><i>Fig. 11 Function buttons</i></p>	<p>Function buttons (from left to right)</p> <table border="1" data-bbox="831 846 1386 1066"> <thead> <tr> <th>Button</th> <th>Submenu "Submenu"</th> <th>List of all submenus</th> </tr> </thead> <tbody> <tr> <td>Button</td> <td>Main screen "Home"</td> <td>Jumps directly to the first screen page</td> </tr> <tr> <td>Button</td> <td>Back "Back"</td> <td>Always jumps back one level</td> </tr> </tbody> </table>	Button	Submenu "Submenu"	List of all submenus	Button	Main screen "Home"	Jumps directly to the first screen page	Button	Back "Back"	Always jumps back one level
Button	Submenu "Submenu"	List of all submenus								
Button	Main screen "Home"	Jumps directly to the first screen page								
Button	Back "Back"	Always jumps back one level								
 <p><i>Fig. 12 Corner function buttons</i></p>	<p>Corner menu selection buttons</p> <p>Direct menu buttons for the selection menus located in the 4 screen corners; arranged around the rotary encoder.</p>									
 <p><i>Fig. 13 Rotary encoder with push-knob</i></p>	<p>Rotary encoder with push-knob</p> <p>Moves the pointer (cursor) on the screen clockwise or counter clockwise. Positions reached are highlighted in colour and are activated by pressing the rotary encoder knob.</p>									

4.2.2 Operating elements

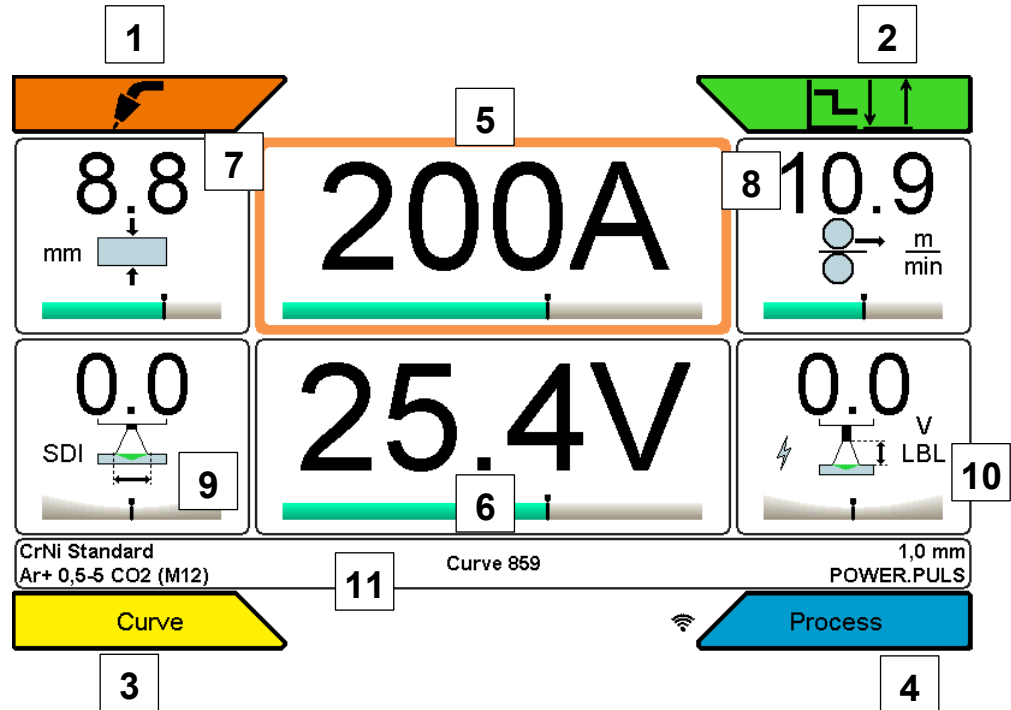

Figure 14: Screen functions

No.	Symbols	Description / function
BF1		Corner menu welding processes
BF2		Corner menu operating modes
		2 cycle
		2 cycle with slope-down
		4 cycle
		4 cycle with slope-down
		Spot
		Spot with slope-down
		2 cycle Interval
		2 cycle Interval with slope-down
		4 cycle Interval
		4 cycle Interval with slope-down

No.	Symbols	Description / function
BF3		<p>Corner menu characteristic curve</p>
		<p>Material group Material Diameter Gas Process Number</p>
BF4		<p>Corner menu welding process</p>
		<p>FOCUS.ARC FOCUS.PULS FOCUS.ROOT POWER.ARC (GMAW) POWER.PULS (Selection depending on the selected filler material and equipment of the system)</p>
BF5		<p>Display panel Welding current (A)</p>
BF6		<p>Display panel Voltage (V)</p>
BF7		<p>Display panel Material thickness (mm)</p>
BF8		<p>Display panel Wire feed speed (m/min)</p>
BF9		<p>Display panel SDI</p>
BF10		<p>Display panel LBL (Arc length)</p>
BF11		<p>Characteristic curve info bar</p>
<p>M01 Custom Gas 1 Curve 999 Custom Ø 1 Power.Puls</p>		

Table 2 Operating elements main screen

No.	Symbols	Description / function
BF12		Sub menu buttons
BF13		GMAW-Parameters
BF14		Job Memory
BF15		Setup (Settings)
BF16		Language
BF17		Back button "Home" and "Back"
BF18		Fault message
BF19		Left in the characteristic curve info bar Display Operation and excess temperature

Table 3 Other control functions and submenus

4.3 Switching on

The FOCUS.ARC P/S and MEGA.ARC P/S welding systems are started with the mains switch. The screen shows the Rehm logo and the unit type for approximately 10 seconds. The display then switches to the main screen [Fig. 10 Main screen]. The last active welding parameters are set. The unit is then ready for operation.

4.4 Peculiarities of the operating panel



The processor control provides active support to facilitate faster and easier operation:

All set parameters are saved when the unit is switched off. When the unit is switched back on the stored parameters are automatically activated. An arc must be struck for any changes to the parameters to be saved when the unit is switched off.

The currently set parameters and settings are always displayed.

If the rotary encoder [Fig.] or button is not actuated for 20 seconds, then the unit returns automatically to the main menu. The basic state therefore always displays the welding current and the same starting position when operating.

Note! Due to software updates or equipment updates, functions may be available on your FOCUS.ARC P/S and MEGA.ARC P/S that are not described in these operating instructions or that are not included in your FOCUS.ARC P/S and MEGA.ARC P/S.

5 Corner menu functions

5.1 Corner menu welding processes (top left)

The corner menu [\[BF1\]](#) is used to select the welding processes

- MIG/MAG (MSG inert gas metal welding)

Turning and pressing the rotary encoder [Fig.] selects and confirms the process. Pressing the button [\[BF17\]](#) "Back or "Rehm" returns to the main screen [Fig.].

5.1.1 GMAW

With stepless GMAW, there are very different material transitions and also different arc types depending on the selected arc power and the shielding gas used, see also point 5.4 (welding process).

Only synergic characteristics are used in MSG welding. To do this, select the synergy characteristic corresponding to the filler material, shielding gas, etc. used.

5.1.2 GMAW manual

With stepless GMAW, welding is carried out without a synergy characteristic. Use this welding process if you cannot find a suitable characteristic for your filler material.

You must manually adjust the voltage and wire feed speed.

5.1.3 MMA

Use this welding process for MMA welding (Stick-welding). Connect the electrode holder and ground cable to the sockets according to the desired polarity. Once the welding process is activated, open circuit voltage is present for welding.

5.1.4 Gouging

Use this welding process for gouging. Connect the gouging machine and ground cable to the sockets according to the required polarity. As soon as the welding process is activated, open circuit voltage is present for gouging.

5.2 Corner menu operating mode (top right)

The menu Operating modes [BF2] is activated by pressing the button at the top right of the keypad Fig. This allows the selection of the operating modes

1. 2 cycle
2. 2 cycle with slope-down
3. 4 cycle
4. 4 cycle with slope-down
5. Spot
6. Spot with slope-down
7. 2 cycle interval
8. 2 cycle interval with slope-down
9. 4 cycle interval
10. 4 cycle interval with slope-down

5.2.1 2 cycle operating mode

The 2 cycle mode is recommended for fast, controlled tacking and manual spot welding.

- 1. cycle Operate the torch trigger
 - The inert gas solenoid valve opens
 - After the set gas pre-flow time has expired the power unit is switched on
 - Welding voltage on
 - Wire feed runs at the initial wire feed speed
 - Arc is ignited after the welding wire contacts the workpiece
 - The feed switches to the set wire feed speed of the welding process
 - The welding current flows with the set Hotstart value
 - After the Hotstart time has elapsed, the welding current is adjusted from the Hotstart value to the welding current over the duration of the Hotstart slope time
- 2. cycle Release the torch trigger
 - Wire feed stops
 - Free burn and free burn control are executed
 - The inert gas is switched off after the gas post-flow time has expired

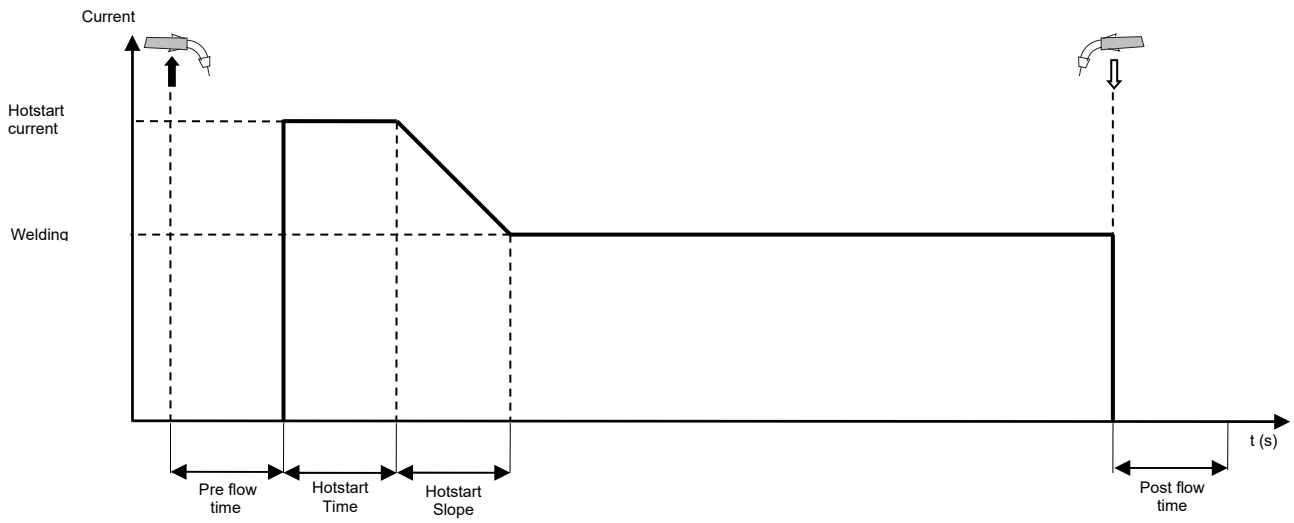

Figure 15: 2 cycle operating mode procedure with Hotstart

5.2.2 2 cycle operating mode with slope-down (Slope)

2 cycle operating mode procedure with slope-down (Slope):

- ❑ 1. cycle Operate the torch trigger
 - ❑ The inert gas solenoid valve opens
 - ❑ After the set gas pre-flow time has expired the power unit is switched on
 - ❑ Welding voltage on
 - ❑ Wire feed runs at the initial wire feed speed
 - ❑ Arc is ignited after the welding wire contacts the workpiece
 - ❑ The feed switches to the set wire feed speed of the welding process
 - ❑ The welding current flows with the set Hotstart value
 - ❑ After the Hotstart time has expired, the welding current is changed from the Hotstart value to the value set for welding over the duration of the Hotstart slope time.
- ❑ 2. cycle Release the torch trigger
 - ❑ For the duration of the slope-down time, the welding current is reduced to the value set for the slope-down current
 - ❑ The wire feed stops after the slope-down time has expired
 - ❑ Free burn and free burn control are executed
 - ❑ The inert gas is switched off after the gas post-flow time has expired

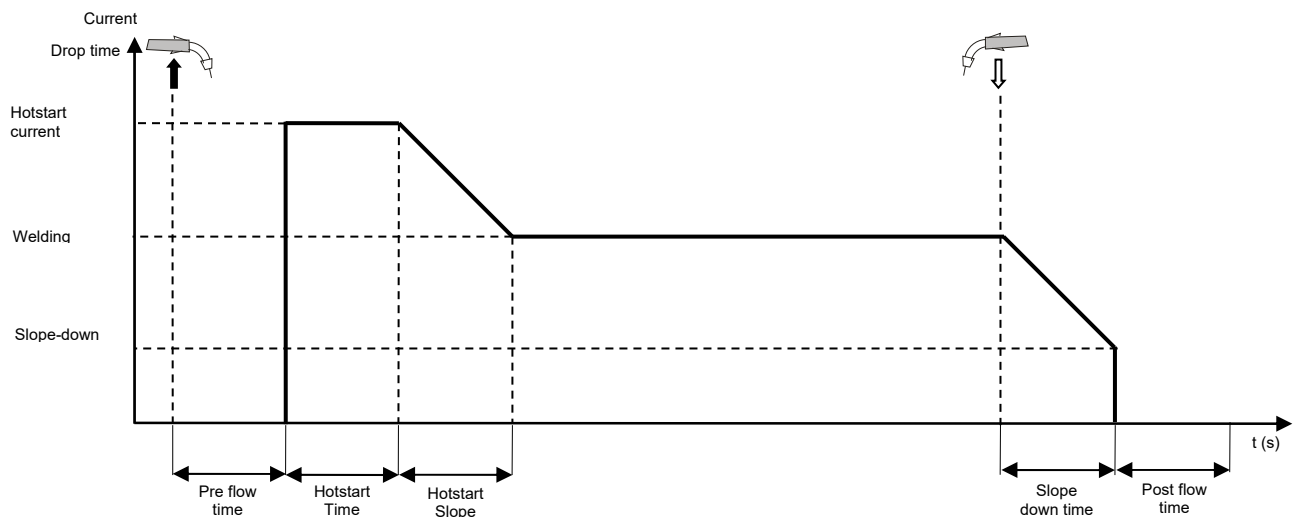

Figure 16: 2 cycle operating mode procedure slope-down (Slope) with Hotstart

5.2.3 4 cycle operating mode

4 cycle welding is recommended for longer welding seams.

4 cycle operating mode procedure:

- 1. cycle Operate the torch trigger
 - The inert gas solenoid valve opens
 - After the set gas pre-flow time has expired the power unit is switched on
 - Welding voltage on
 - Wire feed runs at the initial wire feed speed
 - Arc is ignited after the welding wire contacts the workpiece
 - The feed switches to the set wire feed speed of the welding process
 - The welding current flow is at the set Hotstart value set for welding
- 2. cycle Release the torch trigger
 - The welding current is changed from the Hotstart value to the value set for welding
- 3. cycle Operate the torch trigger
 - Actuating the torch trigger has no effect
- 4. cycle Release the torch trigger
 - Wire feed stops
 - Free burn and free burn control are executed
 - The inert gas is switched off after the gas post-flow time has expired

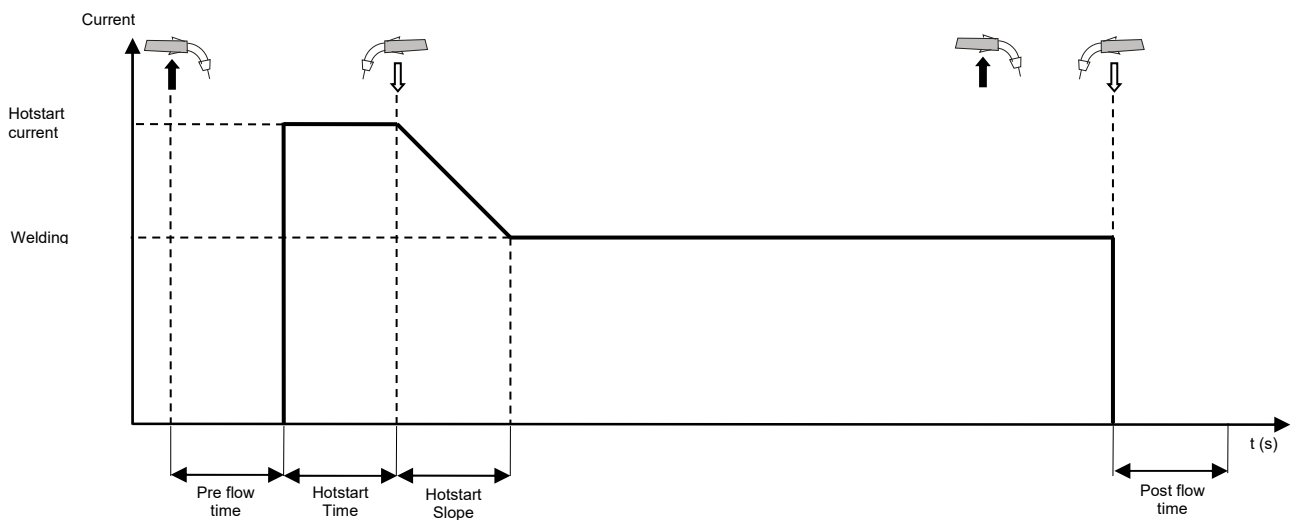

Figure 17: The 4 cycle operating mode procedure with Hotstart

5.2.4 4 cycle operating mode with slope-down (Slope)

4 cycle operating mode procedure with slope-down (Slope):

- 1. cycle Operate the torch trigger
 - The inert gas solenoid valve opens
 - After the set gas pre-flow time has expired the power unit is switched on.
 - Welding voltage on
 - Wire feed runs at the initial wire feed speed
 - Arc is ignited after the welding wire contacts the workpiece
 - The feed switches to the set wire feed speed of the welding process
 - The welding current flows with the set Hotstart value
- 2. cycle Release the torch trigger
 - The welding current is changed from the Hotstart value to the value set for welding
- 3. cycle Operate the torch trigger
 - For the duration of the slope-down time, the welding current is reduced to the value set for the slope-down current
- 4. cycle Release the torch trigger
 - Wire feed stops
 - Free burn and free burn control are executed
 - The inert gas is switched off after the gas post-flow time has expired

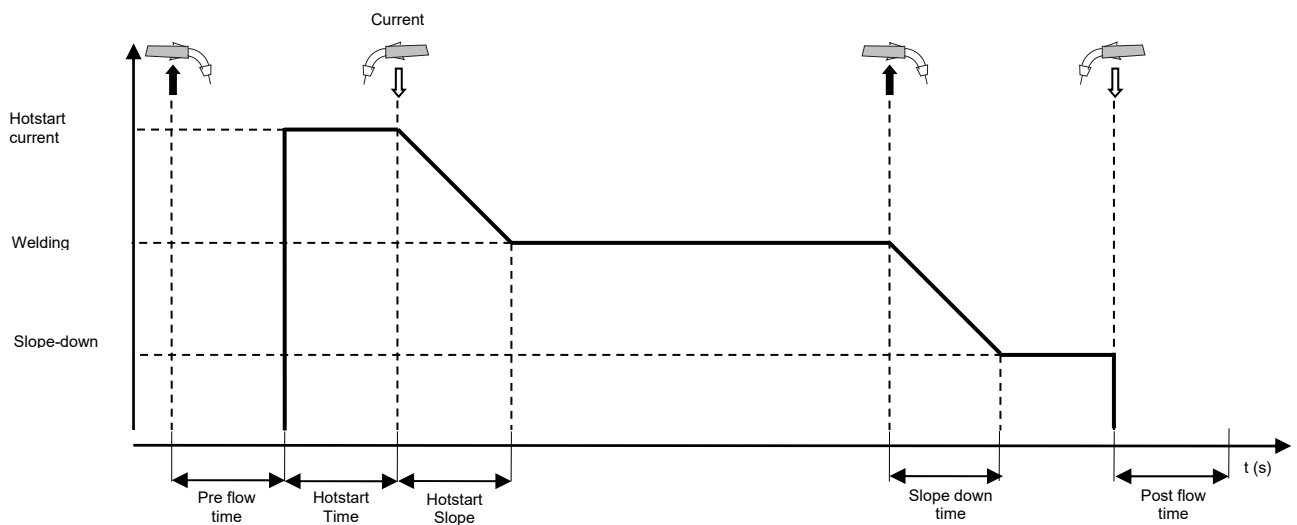

Figure 18: 4 cycle operating mode procedure slope-down (Slope) with Hotstart

5.2.5 Spot

The spot welding mode is recommended for welding with a fixed spot welding time from 0.1 seconds.

The stationary welding process runs with a fixed spot welding time, unless the trigger is released prematurely during the welding.

The program runs to the end after expiry of the set spot welding time or after releasing the torch trigger during the welding.

Spot function procedure:

- 1. cycle Operate the torch trigger
 - The inert gas solenoid valve opens
 - After the set gas pre-flow time has expired the power unit is switched on
 - Welding voltage on
 - Wire feed runs at the initial wire feed speed
 - Arc is ignited after the welding wire contacts the workpiece
 - The feed switches to the set wire feed speed of the welding process
 - The welding current flow is at the set value set for welding
 - The spot time (welding time) is running
 - The welding process is automatically terminated after the set spot time has expired
 - Wire feed stops
 - Free burn and free burn control are executed
 - The inert gas is switched off after the gas post-flow time has expired
- 2. cycle - Release the torch trigger
 - By releasing the torch trigger during the spot time, the welding process is terminated immediately and the inert gas is switched off after the gas post-flow time has expired.

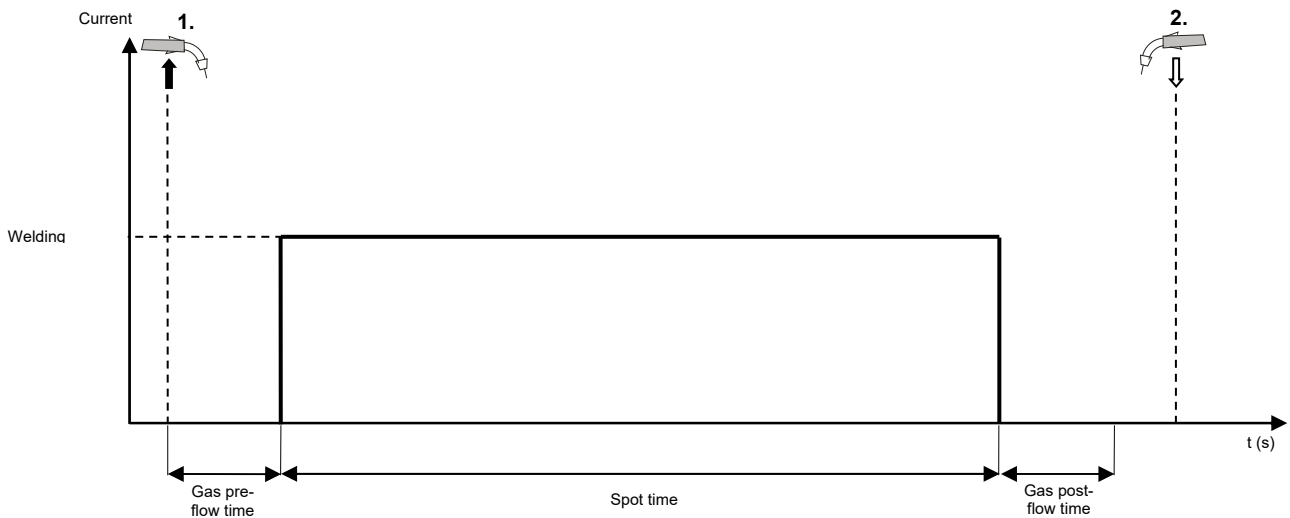

Figure 19: Spot operating mode procedure

5.2.6 Spot with slope-down (Slope)

Spot operating mode procedure with slope-down (Slope):

- 1. cycle Operate the torch trigger
 - The inert gas solenoid valve opens
 - After the set gas pre-flow time has expired the power unit is switched on
 - Welding voltage on
 - Wire feed runs at the initial wire feed speed
 - Arc is ignited after the welding wire contacts the workpiece
 - The feed switches to the set wire feed speed of the welding process
 - The welding current flow is at the set value set for welding
 - The spot time (welding time) is running
 - The welding process is automatically terminated after the set spot time has expired
 - The wire feed stops after the slope-down time has expired
 - For the duration of the slope-down time, the welding current is reduced to the value set for the slope-down current
 - The wire feed stops after the slope-down time has expired
 - Free burn and free burn control are executed
 - The inert gas is switched off after the gas post-flow time has expired
- 2. cycle - Release the torch trigger
 - By releasing the torch trigger during the spot time, the welding process is terminated immediately and the inert gas is switched off after the gas post-flow time has expired.

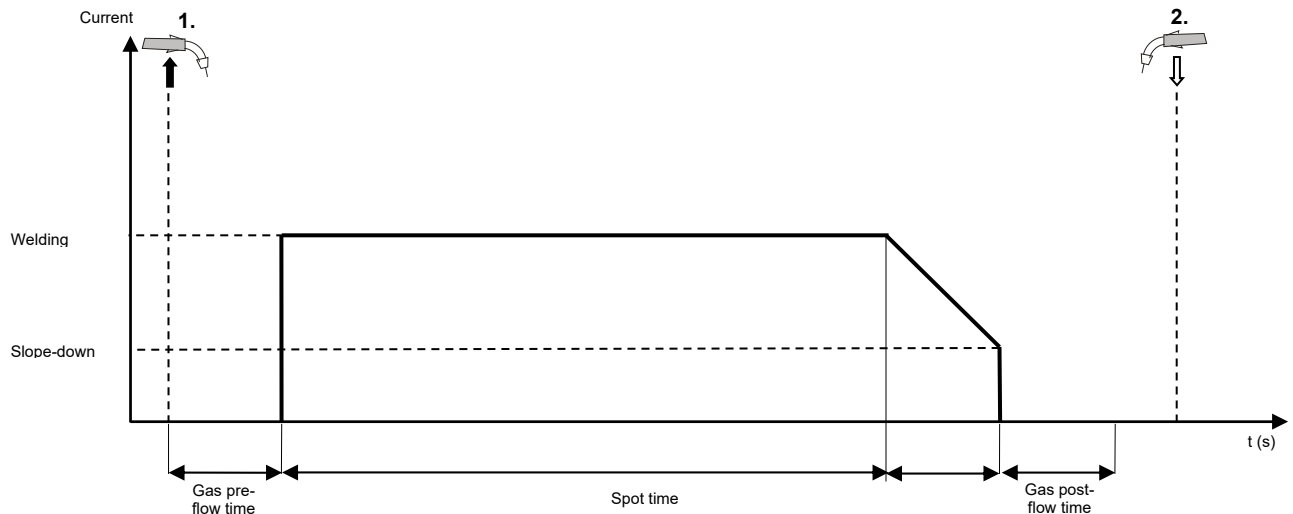

Figure 20: Spot operating mode procedure with slope-down (Slope)

5.2.7 2 cycle interval

Interval welding is defined as spot welding with defined pause times. This makes it possible to apply the thinnest filler materials. Interval welding is only possible in the 2 cycle operating mode.

Welding in the interval welding mode is recommended for welding with a fixed break welding time from 0.01 seconds.

In interval mode the pause time between the single intervals can be adjusted and the cooling of the base material guaranteed, which means less warpage.

2 cycle interval operating mode procedure:

- 1. cycle Operate the torch trigger
 - The inert gas solenoid valve opens
 - After the set gas pre-flow time has expired the power unit is switched on
 - Welding voltage on
 - Wire feed runs at the initial wire feed speed
 - Arc is ignited after the welding wire contacts the workpiece
 - The feed switches to the set wire feed speed of the welding process
 - The welding current flow is at the set value set for welding
 - The welding time is running
 - The welding process is automatically terminated after the set welding time has expired
 - Wire feed stops
 - Freeband and freeband control are executed
 - The inert gas continues to flow
 - The pause time is running
 - After the pause time has expired, the welding process is restarted and the previously described procedure is repeated.
- 2. cycle Release the torch trigger
 - Wire feed stops
 - Free burn and free burn control are executed
 - The inert gas is switched off after the gas post-flow time has expired

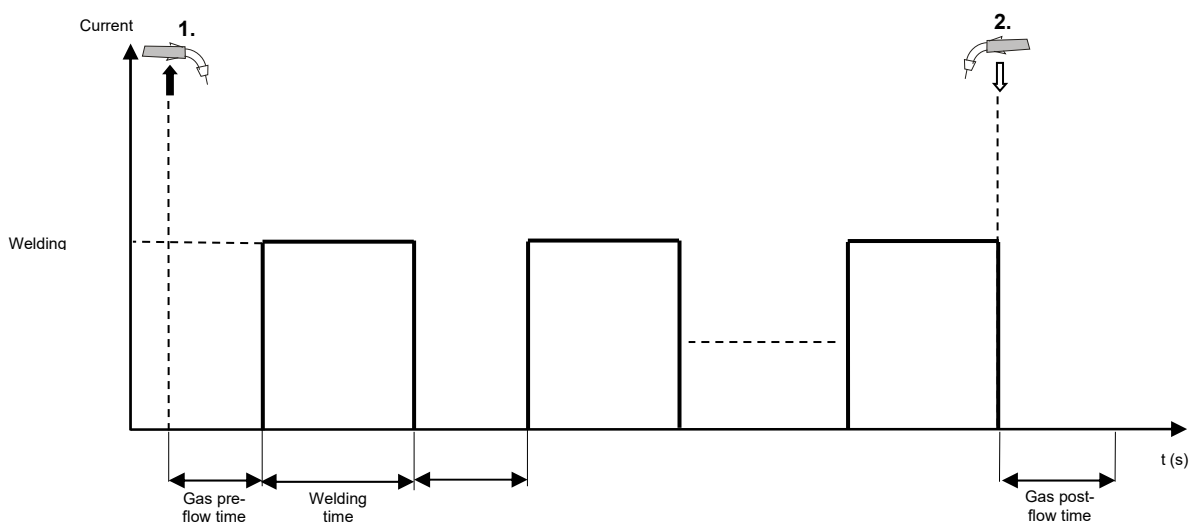

Figure 21: 2 cycle interval operating mode procedure

5.2.8 2 cycle interval with slope-down (Slope)

2 cycle interval operating mode procedure with slope-down (Slope):

- 1. cycle Operate the torch trigger
 - The inert gas solenoid valve opens
 - After the set gas pre-flow time has expired the power unit is switched on
 - Welding voltage on
 - Wire feed runs at the initial wire feed speed
 - Arc is ignited after the welding wire contacts the workpiece
 - The feed switches to the set wire feed speed of the welding process
 - The welding current flow is at the set value set for welding
 - The welding time is running
 - After the set welding time has expired, the welding current is reduced to the value set for the slope-down current over the duration of the slope-down time
 - Wire feed stops after the slope-down time has expired
 - Free burn and free burn control are executed
 - The inert gas continues to flow
 - The pause time is running
 - After the pause time has expired, the welding process is restarted and the welding process runs again
- 2. cycle Release the torch trigger
 - For the duration of the slope-down time, the welding current is reduced to the value set for the slope-down current
 - The wire feed stops after the slope-down time has expired
 - Free burn and free burn control are executed
 - The inert gas is switched off after the gas post-flow time has expired

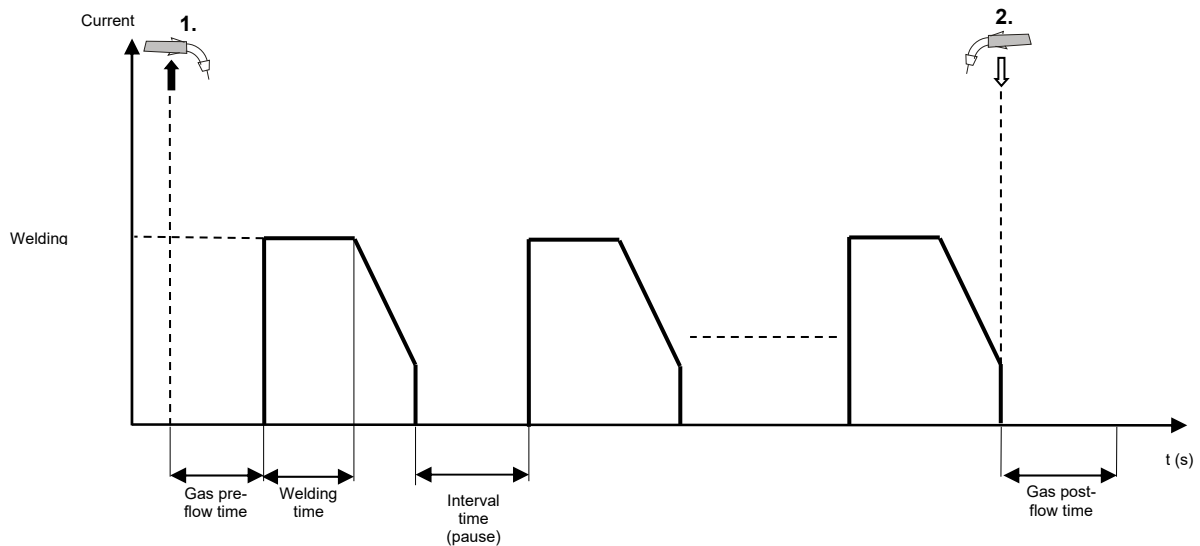

Figure 22: 2 cycle interval operating mode procedure with slope-down (Slope)

5.2.9 4 cycle interval with Hot-start

4 cycle interval operating mode procedure with Hot-start

- 1. cycle Operate the torch trigger
 - The inert gas solenoid valve opens
 - After the set gas pre-flow time has expired the power unit is switched on
 - Welding voltage on
 - Wire feed runs at the initial wire feed speed
 - Arc is ignited after the welding wire contacts the workpiece
 - The feed switches to the set wire feed speed of the welding process
 - The welding current flow is at the set Hotstart value set for welding
- 2. cycle Release the torch trigger
 - The welding current is changed from the Hotstart value to the value set for welding
 - The spot time (welding time) is running
 - The wire feed automatically stops after the set spot time has expired
 - Wire feed stops
 - Free burn and free burn control are executed
 - The pause time is running
 - After the pause time has expired, the welding process is restarted and the welding process runs again
- 3. cycle Operate the torch trigger
- 4. cycle Release the torch trigger
 - The welding process stops
 - Free burn and free burn control are executed
 - The inert gas is switched off after the gas post-flow time has expired

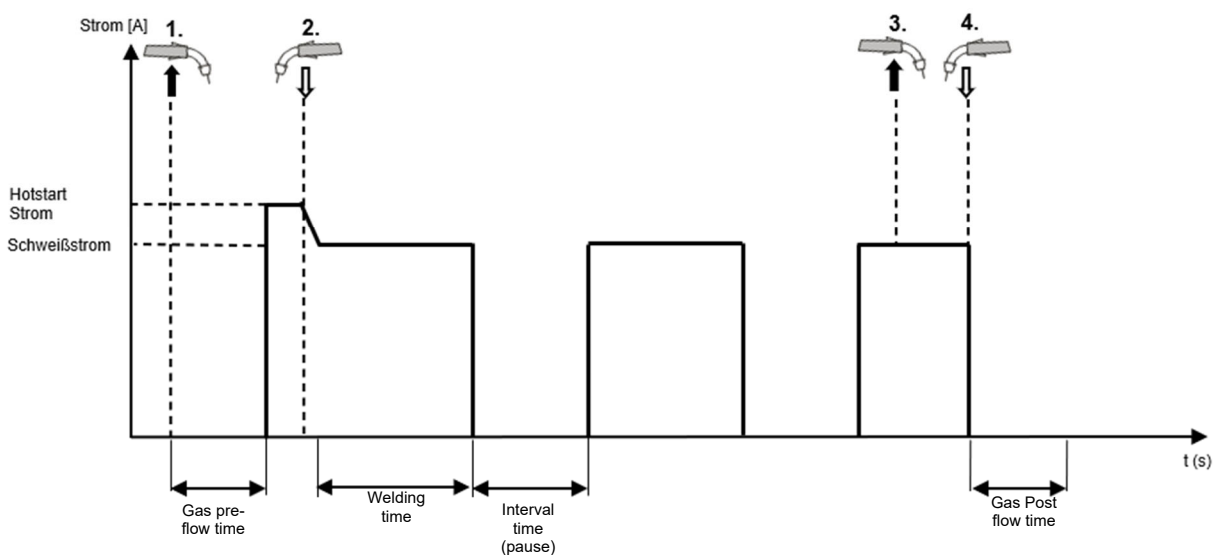

Figure 23: 4 cycle interval operating mode procedure with Hotstart

5.2.10 4 cycle interval with slope-down (Slope)

4 cycle interval operating mode procedure with slope-down (Slope)

- 1. cycle Operate the torch trigger
 - The inert gas solenoid valve opens
 - After the set gas pre-flow time has expired the power unit is switched on
 - Welding voltage on
 - Wire feed runs at the initial wire feed speed
 - Arc is ignited after the welding wire contacts the workpiece
 - The feed switches to the set wire feed speed of the welding process
 - The welding current flow is at the set Hotstart value set for welding
- 2. cycle Release the torch trigger
 - The welding current is changed from the Hotstart value to the value set for welding
 - The spot time (welding time) is running
 - The welding process is automatically terminated after the set spot time has expired
 - Wire feed stops
 - Free burn and free burn control are executed
 - The pause time is running
 - After the pause time has expired, the welding process is restarted and the welding process runs again
- 3. cycle Operate the torch trigger
 - For the duration of the slope down time, the welding current is reduced to the value set for the slope down current.
- 4. cycle Release the torch trigger
 - The welding process stops
 - Free burn and free burn control are executed
 - The inert gas is switched off after the gas post-flow time has expired

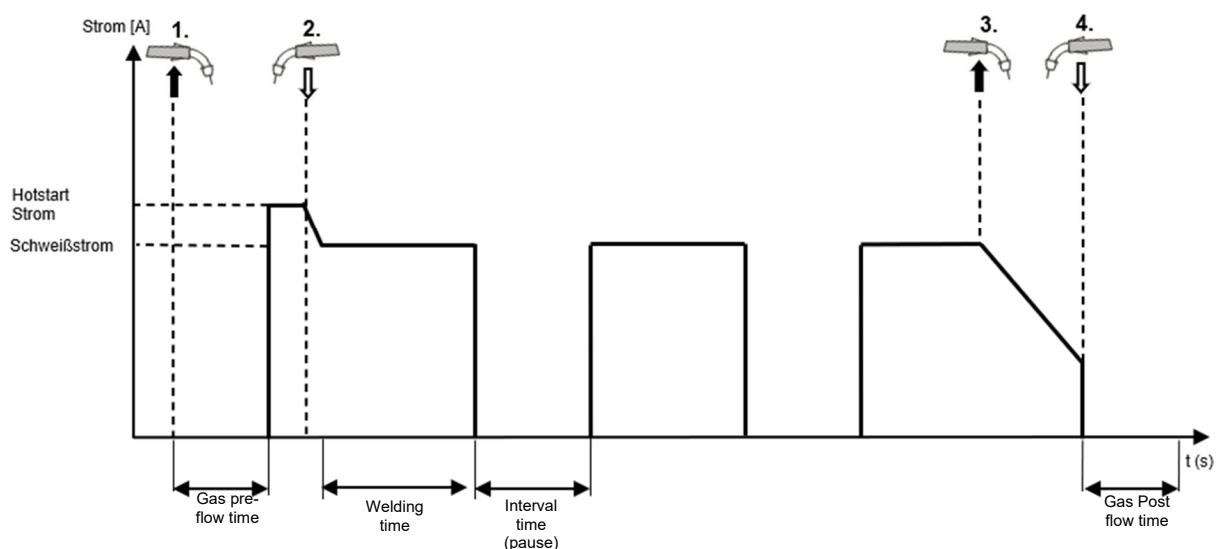

Figure 24: 4 cycle interval operating mode procedure with slope-down (Slope)

5.3 Corner menu characteristic curve

The material, the wire diameter of the inserted welding wire, the gas and the welding process can be selected and adjusted in the corner menu characteristic curve [BF3]. The selected characteristic curve is displayed on the main screen [BF11].

The FOCUS.ARC P and MEGA.ARC P/S provides various programmed characteristic curve data sets for effective processing of different materials. The setting is always made by turning and pressing the rotary encoder.

5.4 Corner menu welding process

Five additional welding processes are available for the GMAW welding process. These differ fundamentally in the material transition of the filler metal, the heat input and the arc length. These Different processes are available depending on the equipment of the welding system and the filler material selected.

The corner menu welding process [BF4] is used to select:

- FOCUS.ARC
- FOCUS.PULS
- FOCUS.ROOT
- POWER.ARC (GMAW)
- POWER.PULS

5.4.1 FOCUS.ARC

The FOCUS.ARC welding process can be selected for conventional GMAW welding with a focused arc.

- Conventional arc
- Welding with a short powerful arc
- Reliable Root acquisition
- Particular deep penetration
- Reliable edge detection
- Reduced undercuts
- Particular for Fe

5.4.2 FOCUS.PULS

The FOCUS.PULS welding process can also be selected for pulsing.

- Pulse arc U/I – controlled
- Voltage controlled bead detachment
- Perfect arc length
- Very good flow properties, flat weld seam geometry
- Low arc energy, deep penetration
- Optimised for the challenges of manual welding
- Safe handling
- Universal applications
- Robust, compensates for tolerances
- Particularly for Fe

5.4.3 FOCUS.ROOT

The FOCUS.ROOT welding process can be selected for root welding.

- Controlled short electric arc
- Energy-controlled bead detachment
- Perfect root coverage
- Easily modulated melt
- Reduced spatter
- Optimised arc energy for root welds
- Optimised for the challenges of manual welding
- Safe handling
- Universal applications
- Robust, compensates for tolerances
- high gap bridging ability
- Particularly for Fe

5.4.1 POWER.ARC (GMAW)

The Power Arc welding process can be selected for conventional GMAW welding.

- Conventional arc
- Optimised for the challenges of manual welding
- Safe handling
- Universal applications
- Robust, compensates for tolerances
- Flat weld seam geometry
- Standardised

5.4.2 POWER.PULS

The POWER.PULS welding process can also be selected for pulsing.

- Pulsed arc I/I controlled
- Frequency controlled bead detachment
- Perfect arc length
- Very good flow properties, flat weld seam geometry
- High arc energy, wide penetration.
- Optimised for the challenges of manual welding
- Safe handling
- Universal applications
- Robust, compensates for tolerances
- Particularly for CrNi and Al

5.5 Display panel Welding current (A)

The required display panel "welding current" [\[BF5\]](#) can be selected by actuating the rotary encoder. The welding current can be set by turning the rotary encoder.

The setpoint of the welding current is displayed in idle mode. The actual welding current is displayed during welding.

5.6 Display panel Voltage (V)

The required "welding voltage" display panel [\[BF6\]](#) can be selected by actuating the rotary encoder. The welding voltage can be set by turning the rotary encoder.

The setpoint of the welding voltage is displayed in idle mode. The actual welding voltage is displayed during welding.

5.7 Display panel Dynamic correction (SDI)

The required "dynamic correction" display panel [\[BF9\]](#) can be selected by actuating the rotary encoder. The dynamic correction can be continuously adjusted by turning the rotary encoder. The possibility of correcting the arc with the dynamics depends on the selected characteristic and equipment of the welding system.

5.8 Display panel LBL correction

The required "LBL correction" display panel [\[BF10\]](#) can be selected by actuating the rotary encoder. The arc length can be continuously adjusted by turning the rotary encoder.

5.9 Display panel Material thickness

The required "material thickness" display panel [\[BF7\]](#) can be selected by actuating the rotary encoder. The material thickness of the base material to be welded can be adjusted by turning the rotary encoder.

5.10 Display panel Wire feed speed

The required "wire feed speed" display panel [\[BF8\]](#) can be selected by actuating the rotary encoder.

The selected wire feed speed is displayed and can be adjusted by turning and pressing the rotary encoder.

5.11 Characteristic curve info bar

In the main screen, the current settings of material, gas, wire thickness, welding process and the characteristic curve number are always displayed in the characteristic curve info bar [\[BF11\]](#).

6. Submenus

Pressing the "Submenus" button [BF12] accesses a selection list (drop down list) for the existing submenu.

The following menu can be selected from this list:

1. GMAW-Parameters
2. Job memory (program)
3. Setting
4. Language

The submenus can be exited in 3 ways, with the return button [BF18]:

1. One level back by acknowledging a setting
2. One level back by pressing the **"Back"** button
3. Completely back to the main screen with the button **"Main menu"** (*Rehm*).

6.1 GMAW-Parameters

With the welding parameters, the user can individually set the most important parameters for welding, such as: Gas pre-flow time, Sneak in, etc.

Some welding parameters are only active when certain welding processes / functions are selected.

6.1.1 Parameter settings

The selection and processing of the welding parameters is carried out for the most part directly in the illustrated welding wave using the push and rotate encoder [Fig.10].

The representation and setting options depend on the unit type and the preselected welding process.

The cursor can be moved clockwise or counter clockwise. The main display always shows the value and function of the cursor position.

6.1.2 Setting the GMAW welding parameters

For processing, a parameter field is activated by rotating the rotary encoder] to the adjustable value field [parameter field] in the screen display and activating this field by pressing the encoder. The background colour of the field changes (is highlighted).

If the parameter field is active, the set value appears as a large display at the top center of the screen (Fig. 21). In addition, a bar display appears in the status field, Figure which shows the set value in the permissible value range.

The welding parameters are described in detail below in the order according to the GMAW parameter curve [BF13].

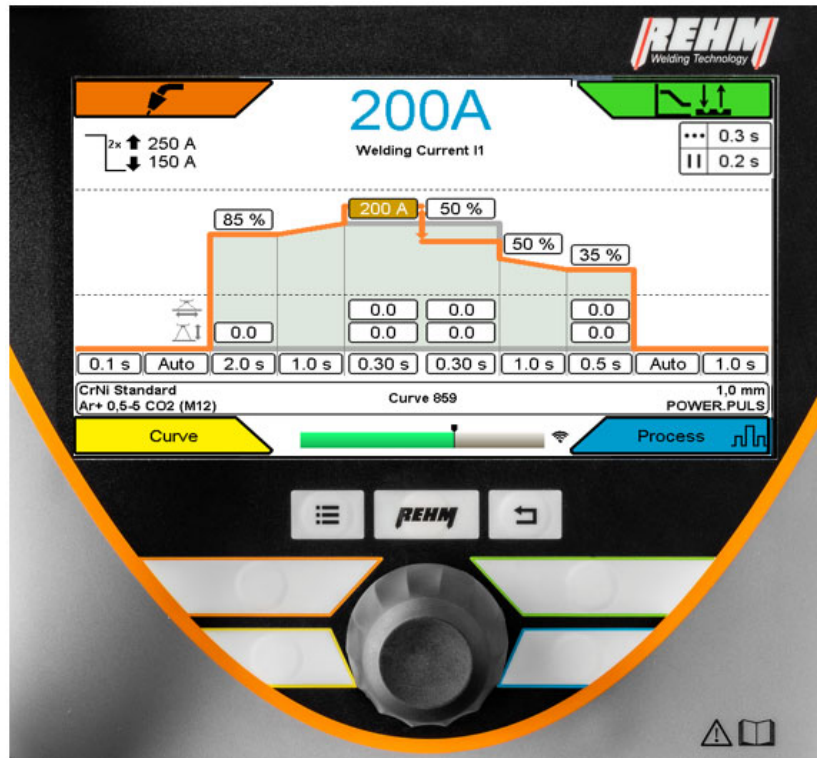

Figure 25: Submenu MSG parameters

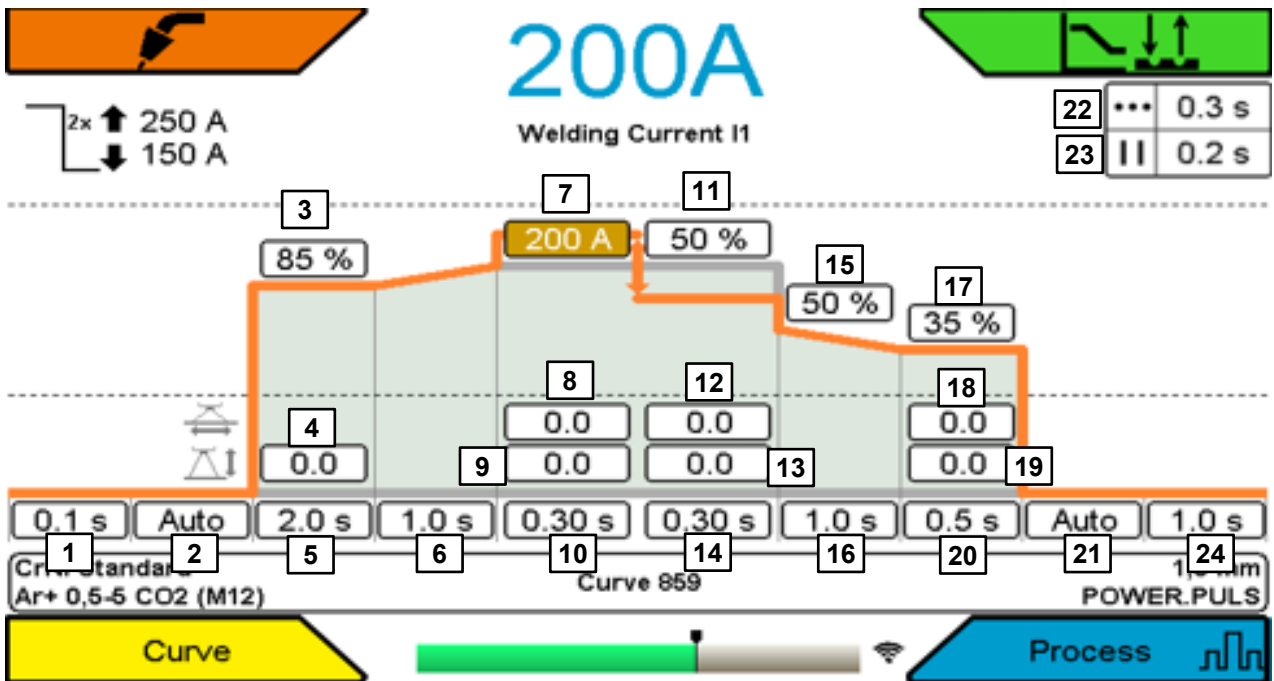

Figure 26: Details GMAW-Parameter

6.1.3 Explanation of welding parameters

1 Gas pre-flow time

Time between switching on the gas valve and the start of the creep in. This parameter depends on the selected characteristic curve, i.e. the gas pre-flow time can be set individually for each characteristic curve.

2 Sneak in wire speed

Adjustment of the sneak in speed. This parameter depends on the selected program, i.e. the sneak in speed can be set individually for each program.

3 Start current

Hotstart energy after ignition, based on the welding energy (100%). Depending on the application, the value can be set lower (setting lower than 100) or higher (setting higher than 100). This parameter depends on the selected characteristic curve, i.e. the hot start value can be set individually for each characteristic curve.

4 Start current: AL-correction

To correct the arc length during the starting current time. This value is independent of arc length correction during welding.

5 Starting current time

The starting current time defines the duration of the Start current. This parameter depends on the selected characteristic curve, i.e. the start current time can be set individually for each characteristic curve.

6 Slope

to set the time in which the current is reduced or increased from the start current to the welding current.

7 Welding current I1

Determines the level of the welding current. Corresponds approximately to the resulting welding current. When welding with double pulse, the average current is displayed according to current1, time current1, current2 and time current2.

(Note: Power sources for MIG/MAG welding work with voltage-controlled processes. The resulting amperage results from the boundary conditions such as torch, ground cable, handling of the torch, etc.)

8 I1 SDI

The dynamic correction for current 1 can be continuously adjusted by turning the rotary encoder. The possibility of correcting the arc with the dynamics depends on the selected characteristic and equipment of the welding system.

9 I1 AL-correction

The arc length for current 1 can be continuously adjusted by turning the rotary encoder.

10 Pulse time T1

Determines the length of time during which current 1 is used for welding.

11 Double pulse amplitude

Determines as a percentage the maximum and base value of the set welding energy for double-pulse welding. For information, the calculated values for current 1 and current 2 are shown in the display field at the top left.

12 I2 SDI

The dynamic correction for current 2 can be continuously adjusted by turning the rotary encoder. The possibility of correcting the arc with the dynamics depends on the selected characteristic and equipment of the welding system.

13 I1 AL-correction

The arc length for current 2 can be continuously adjusted by turning the rotary encoder.

14 Pulse time T2

Determines the length of time during which current 2 is used for welding.

15 Lowering jump

Amount of a current value to which the welding current is suddenly reduced. The welding current drops abruptly to this current after the end of the welding process. This jump prevents an increase in the weld seam width at an end crater and ensures that the end crater is closed.

16 Lowering time

Time period for the slope-down of the welding current to the reduction current. This parameter depends on the selected characteristic curve, i.e. the slope-down time can be set individually for each characteristic curve.

17 End crater current

End crater current after which the lowering time has expired. The end crater current refers to the welding current (100%). This parameter depends on the selected characteristic, i.e. the lowering value can be set individually for each characteristic.

18 Lowering: SDI

The dynamic correction for end crater current can be continuously adjusted by turning the rotary encoder.

19 Lowering: AL-correction

The arc length for end crater current can be continuously adjusted by turning the rotary encoder.

20 End crater time

Period of time in which the end crater current is maintained.

21 Free burning

Time between switching off the wire feed and switching off the power unit. This parameter changes the free burn (characteristic value) predefined for each characteristic and allows the length of the free wire end at the end of welding to be adjusted individually.

A higher value for the free burn gives a shorter free end of the wire (since the wire burns back longer) and a lower value gives a longer end of the wire.

22 Spot time

Welding time in the operating modes spot and interval, if the torch trigger is not released prematurely.

Interval time

Pause time in interval mode (time between 2 spots).

Gas post flow time

Time between the power section being switched off (end of burning off time) and the gas valve being switched off. This parameter depends on the selected characteristic curve, i.e. the gas post flow time can be set individually for each characteristic curve.

6.2 Language menu

The available languages are displayed as flags in a selection list.
Use the cursor to select a language and confirm by pressing the rotary encoder.
The language becomes active immediately.
The selected language is illustrated by a box with cross.

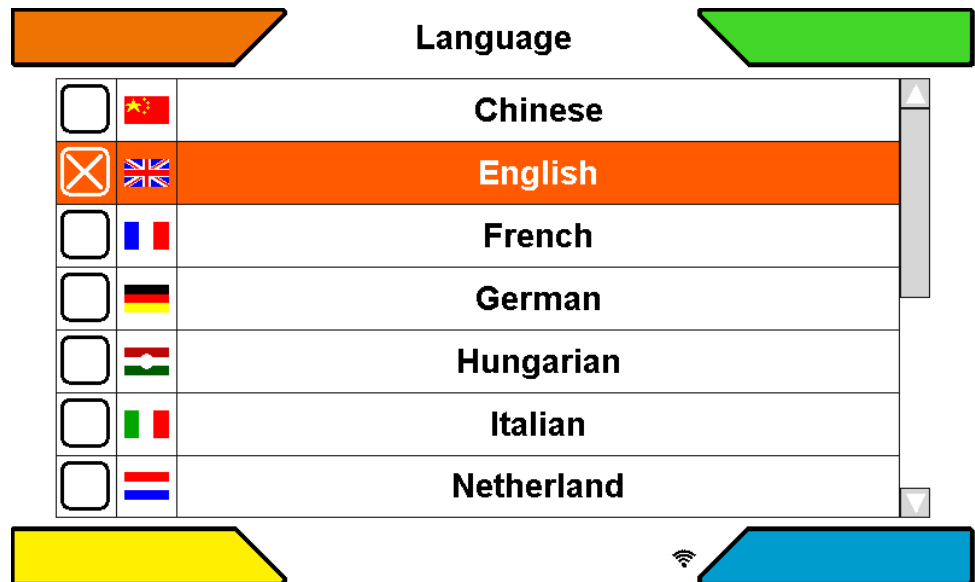

Figure 27: Sub menu Language selection [BF14]

6.3 Saving and loading jobs

The Jobs submenu allows loading, saving and deleting of up to 500 jobs. The jobs can be saved and loaded under a freely selectable name in a freely selectable folder. Once the unit settings for recurring welding tasks have been determined, they can be quickly recalled and reset on the welding unit.

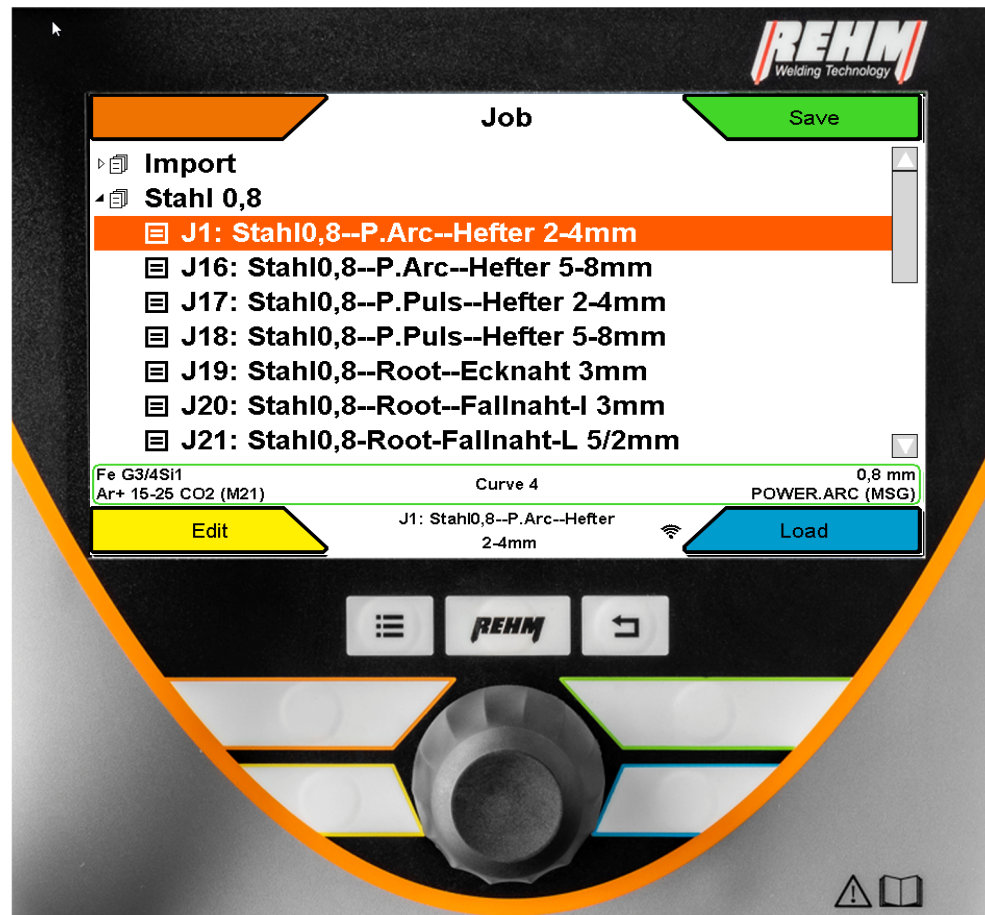

Figure 28: Submenu Job [\[BF16\]](#)

6.3.1 Save job

- Carry out the required machine setting
- Pressing the "Submenus" button [\[BF12\]](#) accesses a selection list (drop down list) for the existing submenu.
- Select the Job Memory by turning and pressing the rotary encoder
- Select a desired folder by turning and pressing the rotary encoder and display the contents of the folder. Select the Save function by pressing the Corner menu key. The selected field is highlighted in orange.
- To create a new job, position the cursor on the folder name. The job is saved by selecting and pressing the "ok" field.
- To overwrite a job, position the cursor on the job to be overwritten
- Select the Save function by pressing the top right button.

Function description

- The query may appear: Save as new job or overwrite?
- Enter the desired name in the job memory by turning and pressing the rotary encoder (e.g. name of an employee, name of a customer and/or material). The job name can be up to 40 characters long.
- The job is saved by selecting and pressing the "ok" field.
- Press the "Home" button[BF18] to return to the main screen.

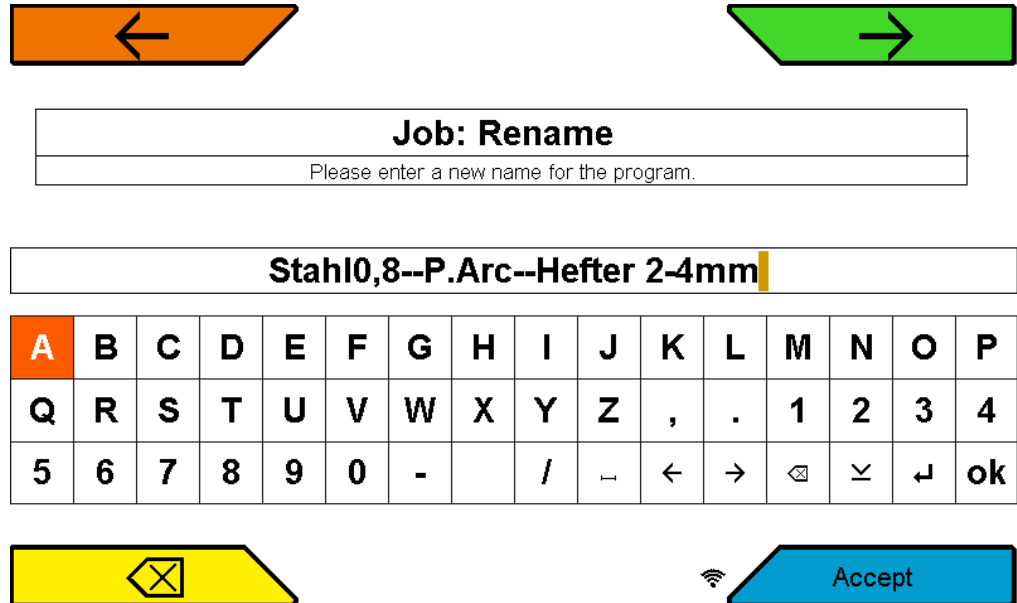

Figure 8: Submenu Job / Text input

Symbol	Funktion
	insert spaces
←	cursor to the left
→	cursor to the right
⊗	Delete letter to left of cursor
↵	lowercase
↵	New line

Table 4 Explanation symbols Text input

6.3.2 Load job

- Pressing the "Submenus" button [BF12] accesses a selection list (drop down list) for the existing submenu.
- Select the Job folder by turning and pressing the rotary encoder
- Select the required field by turning and pressing the rotary encoder. The selected field has a blue frame.
- To preview the settings of the selected job, press the rotary encoder.
- Select "Load" or "Back" in the upper status bar using the rotary encoder
- Select the Load function by pressing the Corner menu key. The selected field is highlighted in orange
- Press the "Home" button to return to the main screen
- The loaded job is displayed in the status bar on the main screen

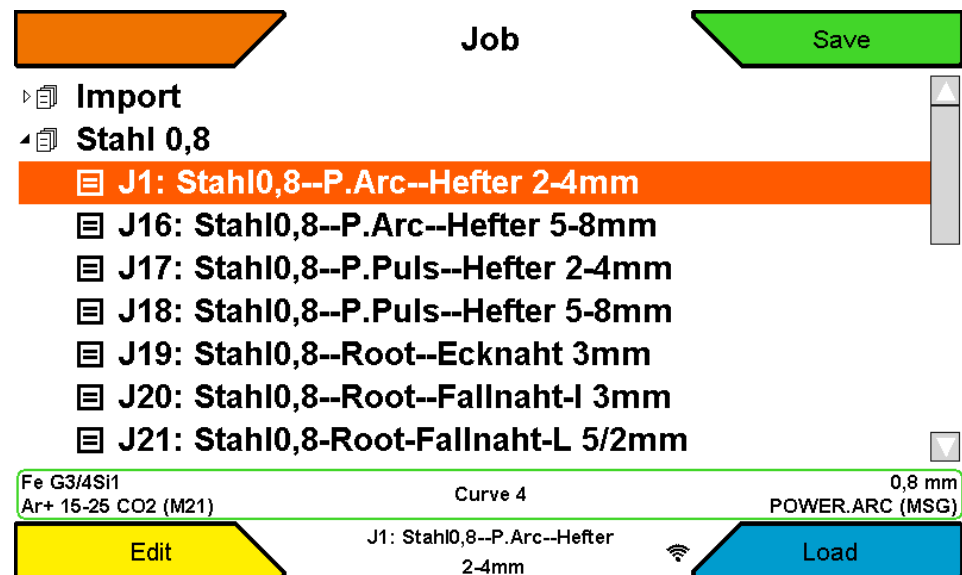

Figure 30: Main screen / Status bar displaying selected job

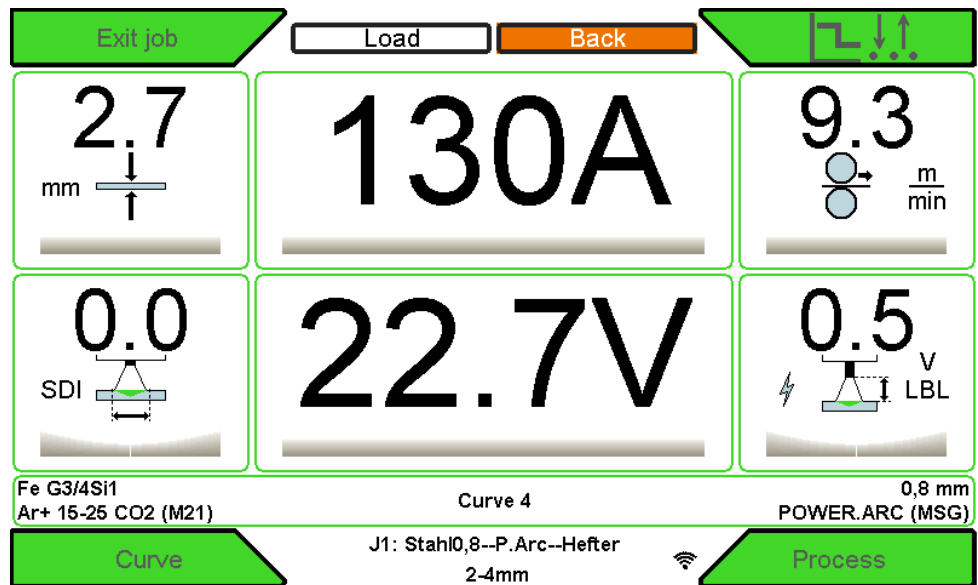

Figure 31: View job memory / job preview

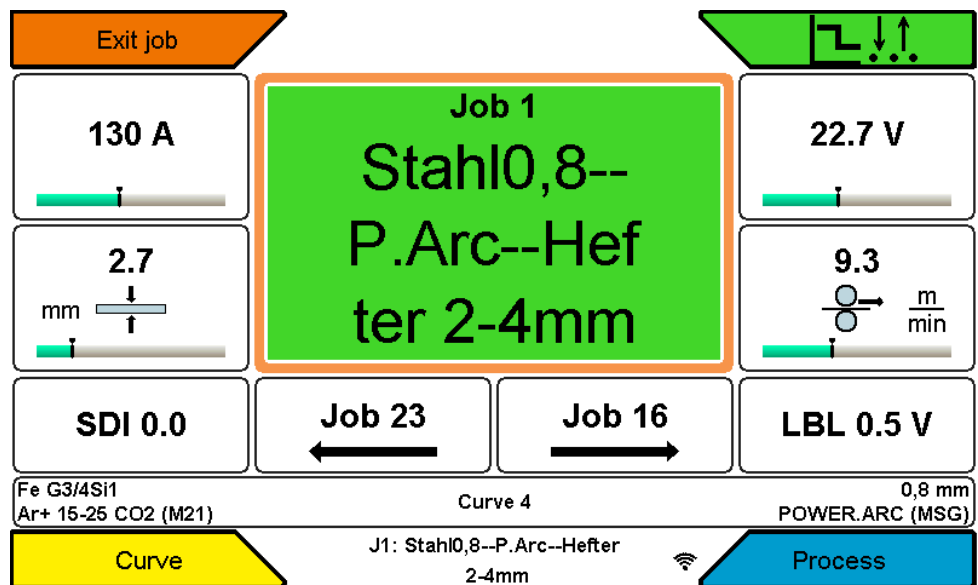

Figure 32: Main view with active job

6.3.3 Edit jobs and folders

- ❑ Pressing the "Submenus" button [BF12] accesses a selection list (drop down list) for the existing submenu.
- ❑ Select the desired function by turning and pressing the rotary encoder
- ❑ Press the "Home" button to return to the main screen.

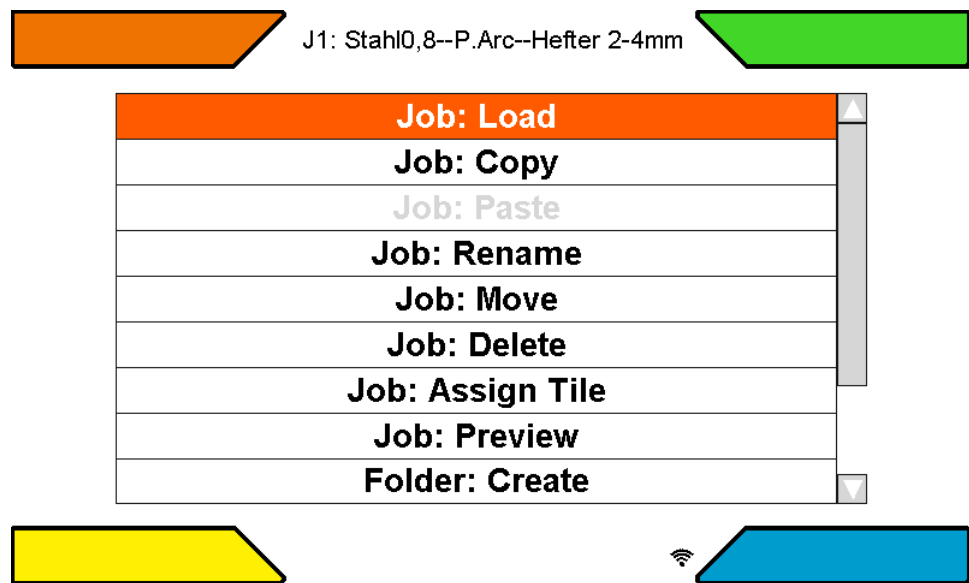

Figure 33: Edit jobs and folders

Function description

Job: Load

By pressing this function you can load the selected job

JOB: Copy

By pressing this function, the selected job is copied to the clipboard. The job can then be pasted into another folder as a copy.

JOB: Paste

This function is only active if a job was previously copied to the clipboard. The respective job is stored as a copy in the appropriate folder.

JOB: Rename

The name of the selected job can be customized.

JOB: Move

A job can be moved within the folder using this function.

JOB: Delete

The currently selected job is deleted.

JOB: Preview

Activates the preview of the job in which the most important settings can be read. The job is not loaded.

Folder: Create

This function can be used to create a new folder.

Folder: Rename

The name of the selected folder can be customized.

Folder: Move

The order of the folders can be adjusted

Folder: Delete

A folder can be deleted. Only empty folders can be deleted.

6.4 Setup submenu

Functions and processes can be defined very conveniently and clearly in the Setup submenu.

- By turning the push and turn control [Fig. 13] the desired setting is selected. The settings are logically structured in various subfolders. Some settings depend on the selected characteristic, the selected process, the equipment of the welding system, etc..



Factory settings	▲
Screen	
System	
Welding	▼



Figure 34: Submenu Setup [BF17]



Gastest: Time	20.0 s	▲
Hold Modus	Action and time	
Hold time	20 s	
Welding Circuit: Detect		
Welding Circuit: Inductance	10.0 uH	
Welding Circuit: Resistance	10.0 mOhm	
WLAN: Active	Yes	
WLAN: Channel	7	▼



Figure 35: Submenu Setup / System [BF17]

Function description

Designation	Adjustment	Description
Factory settings		
Characteristic curves		All settings (welding parameters) are reset to factory settings. Does not apply to: job
Screen:		
Color scheme	Bright / Dark	Color change for optimal contrast
Display Mirror: X	No / Yes	
Display Mirror: Y	No / Yes	
Menureset	1s-2:00 min	After the set time, the cursor jumps to its starting position
System		
Gastest: Time	0,1s-60,0s	
Hold: Modus	Inaktiv / Aktion / Aktion und Zeit	Hold values reflect the average current and voltage values of the weld
Hold: Time	10s-2:00min	
Watercooled delayed Shutoff Time	10s – 15:00min	Additional cooling time after welding is complete [Auto]
Watercooling Mode	Off / Auto / On	
Welding Circuit: Detect		Illustrated instructions for adjusting the welding circuit
Schweißkreis: Induktivität	Mikro Henry	For checking the data of the welding circuit adjustment
Schweißkreis: Widerstand	Milli Ohm	For checking the data of the welding circuit adjustment
WLAN Active	No / Yes	
WLAN Channel	1-11	

Welding		
AL control type	Voltage / wire feed	
Double Pulse:	Active / Inactive	Allows for better heat control and seam flaking
Double Pulse Slope: T1/T2	0-5	0: fast to current 2 5: slowly to current 2
Double Pulse Slope: T2/T1	0-5	0: fast to current 1 5: slowly to current 1
Folder Mode	Cycle once / Continuous Cycle	Selection of jobs within a folder
Up-/Down (open-circuit)	Inactive / Power output / JOB / AL adjustment / SDI	Remote control option on welding torch
Up-/Down (welding)	Inactive / Power output / JOB / AL adjustment / SDI	Remote control option on welding torch
Up-/Down: Speed	1-7	1: slow 7: fast

Table 5 Setup submenu

6.5 Welding Circuit: Detect

- ❑ The arcing behavior is e.g. highly dependent on the welding circuit. For example, a long ground cable or intermediate hose package can lead to a significant shortening of the arc length. This in turn can cause heavy spattering. A welding circuit detecting should always be carried out when the FOCUS.ARC P/S or MEGA.ARC P/S welding system is started up.
- ❑ Press the push-turn control on the "Welding circuit detect" parameter.
- ❑ The graphic for the welding circuit adjustment is then displayed on the control panel (Figure 36)
- ❑ The steps for welding circuit detect are:
 - 1: Connect ground cable to workpiece/welding table and welding machine
 - 2: Removing the gas nozzle
 - 3: Placing the current contact tip on the workpiece / welding table
 - 4: Keep the torch trigger pressed for approx. 1s
 - 5: press yellow corner button to accept values

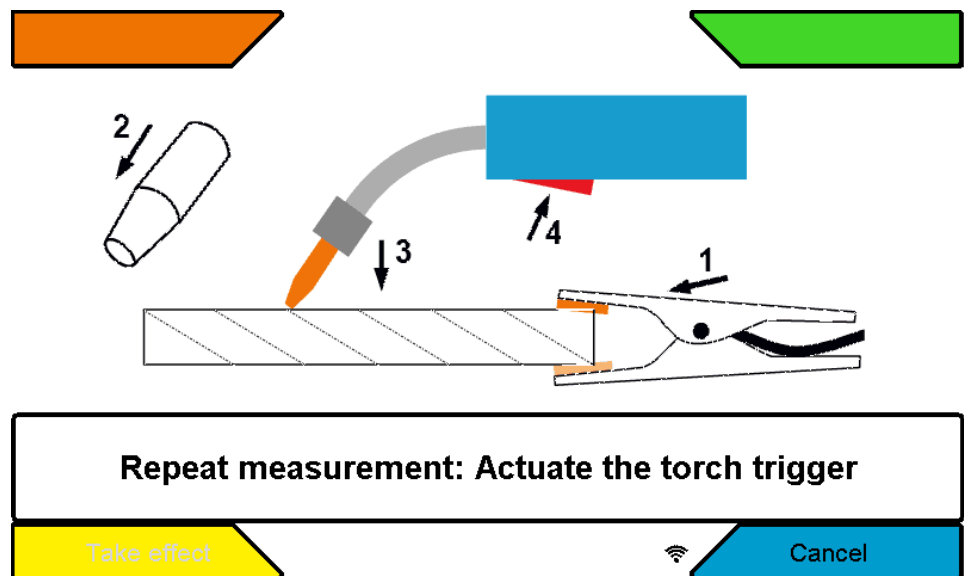



Figure 36: Setup / System / Welding circuit adjustment submenu

7 Control lamps

Symbol	Description
Operation/ excess temperature [BF20] 	<p>The symbol OPERATION in black indicates that there is an open circuit voltage at the torch or electrode holder.</p> <p>The symbol is located on the left in the characteristic curve info bar</p> <p>The symbol illuminates red and flashes in the event of excess temperature.</p>
	<p>The power section is switched off and no output voltage is available as long as this symbol flashes red. After the unit has cooled down, the LED is extinguished and welding can be resumed automatically.</p>

Other functions

8.1 Threading

The threading function is used to thread the welding wire into the torch hose set without current. The welding wire is threaded into the torch hose set by means of the push button above the feed unit (Fig. 4). By pressing the pushbutton "Threading", threading is carried out for 2 seconds at reduced speed. The threading speed is then increased over a period of approx. 2 seconds to the set threading speed.

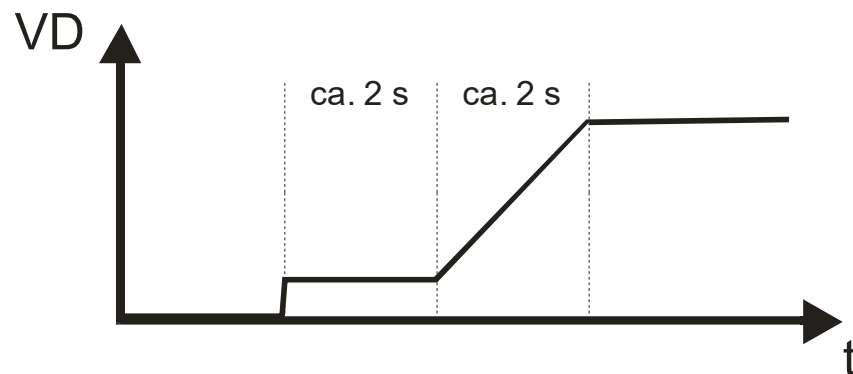

Figure9: Threading procedure

8.2 Gas test

The "gas test" is used to set the required gas quantity at the pressure reducer. This enables the desired gas flow to be set without wire feeding and voltage.

A push button for the gas test is located above the feed unit (Fig. 4). When the push button is pressed, the gas valve is opened and inert gas flows out of the welding torch.

The gas test is automatically terminated after 20 seconds. The gas test can be aborted prematurely by pressing the "Gas test" button or the torch button.

8.3 Water recirculation cooling

Depending on the equipment variant, the FOCUS.ARC P/S or MEGA.ARC P/S welding systems are equipped with water circulation cooling for the welding torch as standard. A flow monitor in the cooling water return monitors the flow rate and issues an error message if it falls below the critical limit of 0.4l/min. This protects the welding torch from overheating due to lack of water cooling.

8.4 Temperature monitoring of the power units

The welding current is automatically switched off if the permissible temperature of the power components transformer and transistor switch is exceeded. This is indicated by the control lamp Operation [BF20] and by an error message in the main screen. After the power components have cooled down, the system automatically switches back to the operating state (without power).

8.5 External cooling of the power units

The power units of the REHM FOCUS.ARC P/S or MEGA.ARC P/S systems are designed for high operational reliability. Optimum heat dissipation with minimum noise generation is achieved by the targeted placement of the cooling fan and the power components.

8.6 Fan and water pump control

The REHM FOCUS.ARC P/S or MEGA.ARC P/ has a demand-oriented fan and water pump control. The fan and the water pump switch on immediately at the start of welding. After completion of the welding process, a follow-up time of 7 minutes is set, which can be changed in the Setup submenu. The fan and the water pump subsequently go into standby. This reduces noise emission, wear and energy consumption.

To ensure perfect torch cooling during the first welding process, the water pump is automatically activated after switching on the mains switch until cooling water flows for 10 seconds in the return flow.

8.7 Polarity selection for self-shielded cored wires

The FOCUS.ARC P oder MEGA.ARC P welding systems have a polarity selector plug. To weld self-shielded cored wires, the plug is plugged into "MINUS" power socket.

For welding using GMAW with shielding gas, the plug is plugged into the "PLUS" power socket. Always ensure that the plug is firmly seated in order to avoid possible overheating.

9 Accessories and options

These operating instructions are based on the accessories approved by REHM.

9.1 Unit versions, accessories and options

MACHINES WITHOUT WIRE FEED CASE (choose undercarriage separate)	
FOCUS.ARC P 300 1,0/1,2mm	1307055
FOCUS.ARC P 300 W 1,0/1,2mm	1307056
FOCUS.ARC P 350 1,0/1,2mm	1307065
FOCUS.ARC P 350 W 1,0/1,2mm	1307066
FOCUS.ARC P 400 1,0/1,2mm	1307075
FOCUS.ARC P 400 W 1,0/1,2mm	1307076
FOCUS.ARC P 450 1,0/1,2mm	1307085
FOCUS.ARC P 450 W 1,0/1,2mm	1307086
MACHINES WITH WIRE FEED CASE (choose undercarriage separate)	
FOCUS.ARC P 300 S 1,0/1,2mm	1307057
FOCUS.ARC P 300 WS 1,0/1,2mm	1307058
FOCUS.ARC P 350 S 1,0/1,2mm	1307067
FOCUS.ARC P 350 WS 1,0/1,2mm	1307068
FOCUS.ARC P 400 S 1,0/1,2mm	1307077
FOCUS.ARC P 400 WS 1,0/1,2mm	1307078
FOCUS.ARC P 450 S 1,0/1,2mm	1307087
FOCUS.ARC P 450 WS 1,0/1,2mm	1307088
OPTIONS	
Housing	
Operation in the machine FOCUS.ARC	1381153
Without undercarriage	1381100
Preparation for trolley	1381385
Trolley including preparation	1381386
Undercarriage Profi (50 l)	1381101
Undercarriage Advanced (50 l with loading rack and fixing brake)	1381102
Top shock proof cover display FOCUS.ARC	1381107
Bottom shock proof cover display FOCUS.ARC	1381108
Toolbox for compact machines	1381143
Air pre-filter	1381144
Crane lifting lugs for wire feed unit	1381146
Drum wire feed through (wire feed unit)	1381147
Option undercarriage for wire feed case	1381150
Holder for torch and hose pack SP ² 250-450/MA ² /MPF M16/SP/IVP	1180214
Centre lock variants	
Adaptor EC-SA Torch connection Dinse	4300318

ACCESSORIES	
Intermediate hose pack gas cooled	
Intermediate hose pack MIG/MAG 50mm ² 1,4m G 12p FA/MA/SP	7505000
Intermediate hose pack MIG/MAG 50mm ² 5m G 12p FA/MA/SP	7505001
Intermediate hose pack MIG/MAG 50mm ² 10m G 12p FA/MA/SP	7505002
Intermediate hose pack MIG/MAG 70mm ² 1,4m G 12p FA/MA/SP	7505010
Intermediate hose pack MIG/MAG 70mm ² 5m G 12p FA/MA/SP	7505011
Intermediate hose pack MIG/MAG 70mm ² 10m G 12p FA/MA/SP	7505012
Intermediate hose pack MIG/MAG 70mm ² 15m G 12p FA/MA/SP	7505013
Intermediate hose pack MIG/MAG 70mm ² 20m G 12p FA/MA/SP	7505014
Intermediate hose pack MIG/MAG 95mm ² 5m G 12p FA/MA/SP	7505021
Intermediate hose pack MIG/MAG 95mm ² 10m G 12p FA/MA/SP	7505022
Intermediate hose pack MIG/MAG 95mm ² 15m G 12p FA/MA/SP	7505023
Intermediate hose pack water cooled	
Intermediate hose pack MIG/MAG 50mm ² 1,4m W 12p FA/MA/SP	7505030
Intermediate hose pack MIG/MAG 50mm ² 5m W 12p FA/MA/SP	7505031
Intermediate hose pack MIG/MAG 50mm ² 10m W 12p FA/MA/SP	7505032
Intermediate hose pack MIG/MAG 70mm ² 1,4m W 12p FA/MA/SP	7505040
Intermediate hose pack MIG/MAG 70mm ² 5m W 12p FA/MA/SP	7505041
Intermediate hose pack MIG/MAG 70mm ² 10m W 12p FA/MA/SP	7505042
Intermediate hose pack MIG/MAG 70mm ² 15m W 12p FA/MA/SP	7505043
Intermediate hose pack MIG/MAG 70mm ² 20m W 12p FA/MA/SP	7505044
Intermediate hose pack MIG/MAG 95mm ² 1,4m W 12p FA/MA/SP	7505050
Intermediate hose pack MIG/MAG 95mm ² 5m W 12p FA/MA/SP	7505051
Intermediate hose pack MIG/MAG 95mm ² 10m W 12p FA/MA/SP	7505052
Intermediate hose pack MIG/MAG 95mm ² 15m W 12p FA/MA/SP	7505053
Intermediate hose pack MIG/MAG 95mm ² 20m W 12p FA/MA/SP	7505054
Torch MIG / MAG gas cooled	
Torch MAG MB 24D 3m G 50° KGK	7601566
Torch MAG MB 24D 4m G 50° KGK	7601567
Torch MAG MB 24D 5m G 50° KGK	7601568
Torch MAG MB 26D 3m G 50° KGK	7601569
Torch MAG MB 26D 4m G 50° KGK	7601570
Torch MAG MB 26D 5m G 50° KGK	7601562
Torch MAG MB 36D 3m G 50° KGK	7601571
Torch MAG MB 36D 4m G 50° KGK	7601561
Torch MAG MB 36D 5m G 50° KGK	7601572
Torch MAG MB 24D 4m UD G 50° KGK	7601024
Torch MIG / MAG water cooled	
Torch MAG W 340D 3m	7601716
Torch MAG W 340D 4m	7601718
Torch MAG W 340D 5m	7601720
Torch MAG W 440D 3m	7601722
Torch MAG W 440D 4m	7601724

Accessories and options

Torch MAG W 440D 5m	7601726
Torch MAG W 540D 3m	7601728
Torch MAG W 540D 4m	7601730
Torch MAG W 540D 5m	7601732
Torch MAG W 340D 7 3m UD	7601717
Torch MAG W 340D 7 4m UD	7601719
Torch MAG W 340D 7 5m UD	7601721
Torch MAG W 440D 7 3m UD	7601723
Torch MAG W 440D 7 4m UD	7601725
Torch MAG W 440D 7 5m UD	7601727
Torch MAG W 540D 7 3m UD	7601729
Torch MAG W 540D 7 4m UD	7601731
Torch MAG W 540D 7 5m UD	7601733
Wear part sets for torch	
Wear parts set MB 24D/240W	7700416
Wear parts set MB 26D	7700418
Wear parts set MB 36D	7700419
Wear parts set W 340	7700621
Wear parts set W 440	7700622
Wear parts set W 540	7700623
Earth cable	
Earth cable 35mm ² 4m 13mm with 400A clamp	7810102
Earth cable 50mm ² 4m 13mm with 500A clamp	7810109
Earth cable 70mm ² 4m 13mm with 600A clamp	7810104
Earth cable 95mm ² 4m 13mm with 600A clamp	7810150
Pressure reducer	
Pressure reducer Optimator Argon/CO ₂ 20	7967932
Pressure reducer Arg/CO ₂ G1/4" 0-30/200bar	7530500
Pressure reducer Arg/CO ₂ G3/8" 0-30/200bar NL	7830164
Basket spool adapter	
Basket spool adapter Industrie	7516000
Basket spool adapter Professional	7516004
Gas hose	
Gas hose ISO3821 6x3,5 2x 1/4" 1,8m	3250001
Inert gas filter G1/4" RH	7501111
Cooling liquid	
Cooling liquid, RCL, 5l	1680051
Cooling liquid, RCL, 25l	1680251
Remote control	
SET MIG-FP 1 + Interface	7501101
Set consists of handheld remote controller 7501004 with 2 controllers and interface 1381285	
Hand-held remote control MIG-FP1 for Interf. FP1	7501004
Hand-held remote control with 2 controls. (requires the interface 1381285)	
Undercarriage	

Trolley	7532026
Mounting kit FA/MA trolley	2103040
FEED ROLLER FOR WIRE FEED UNIT	
Single feed rollers for massive wire	
Feed roller 0,6/0,8mm massive 4/2	7503054
Feed roller 0,8/1,0mm massive 4/2	7503055
Feed roller 1,0/1,2mm massive 4/2	7503053
Feed roller 1,2/1,6mm massive 4/2	7503056
Feed roller 0,9/1,1mm massive 4/2	7503065
Single feed rollers for tube wire	
Feed roller 1,2/1,6mm tube 4/2	7503066
Single feed rollers for aluminium wire	
Feed roller A 1,0/1,2mm alu 4/2	7503069
Feed roller A 1,2/1,6mm alu 4/2	7503070
Feed roller A 1,6/2,4mm alu 4/2	7503071
UPGRADE EQUIPMENT	
Retrofit kit holder for torch and hose pack	7501129
Retrofit kit shock proof cover display top/bottom FOCUS.ARC	7501130
Retrofit kit air pre-filter	7501132
Metal filter FA P (two pieces per attachment)	7503057
Retrofit kit toolbox for compact machines	7501131
Wire feed case	
Retrofit kit driving carriage for wire feed case SP ² /MA ²	7501502
Interfaces	
Interfaces - SET FA to URe series	7504015
Programmed interface including 5m connection cable and installation manual	
Interface FP1 standard 5m	1381285
Start, current flows, two analog values with 5m control line	
SPARE PARTS FOR WIRE FEED UNIT	
Capillary tube up to 1,6mm	7503067
Support tube for teflonfeeder up to 4mm outer diameter	7503068
Clamping pulley left 4/2	7503083
Clamping pulley right 4/2	7503084
Inlet blue ID ø 2.0mm	4000222
Middle wire feed, blue, ID ø 2.0mm	4000223
Pressure unit complete, red SS4-ST4	4000220

10 Commissioning

10.1 Safety instructions

Carefully read the operating instructions, in particular the → **Section 2 Safety**, before commissioning and before beginning work with this welding current source.



Warning!

REHM welding equipment should be operated only by persons who are trained and instructed in the use, maintenance and the safety regulations concerning welding systems.

When welding always wear protective clothing and take care to avoid other persons who may be in the vicinity being endangered by the UV radiation emitted by the welding arc.

10.2 Working under elevated electrical risk in accordance with the regulations from IEC 974, EN 60 974-1, TRBS 2131 and BGR 500 Section 2.26 (previously VGB 15) (S)

The *REHM* - FOCUS.ARC P/S or MEGA.ARC P/S - gas welding equipment complies with the above-mentioned regulations. It must be noted that for work under increased electrical hazard, the welding current source must not be placed in this area. Regulations EN 974-1, TRBS 2131 and BGR 500 Section 2.26 (previously VGB 15) must be observed.

10.3 Positioning the welding unit

Place the *REHM* welding system so that the welder has sufficient space in front of the unit to adjust and operate the controls.

Transport the unit only under compliance with the applicable accident prevention regulations.



ATTENTION: The attachment of the FOCUS.ARC P/S or MEGA.ARC P/S systems for hanging transport, e.g. on ropes or chains, is only permitted with the use of the crane eyelets. Fastening to the handles or other parts of the system is not permitted.

Danger! Electrical voltage!

Do not use the welding unit in the open in the rain!

10.4 Connecting the welding unit

Only connect the REHM welding current source to the power supply in accordance with the applicable VDE regulations and also observe the regulations of the respective professional associations.

When connecting the unit observe the instructions concerning the power supply voltage and local mains fuse. Automatic circuit breakers and fuses must always be sized for the stated source current. The necessary information can be found in →Section 16, Technical Data.

Always switch off the unit when not in use.

Place the inert gas bottle on the bottle bracket provided on the unit and secure with the safety chain. Screw the bottle pressure reducer tightly on the thread, attach the gas hose to the pressure reducer and check the connection for tightness. Always close the bottle valve after completing work. Observe the regulations of the respective professional associations.

10.5 Cooling the welding unit



Place the REHM welding unit so that the air entry and exit ports are not obstructed. The machine can only achieve the specified duty cycle with sufficient ventilation.

Ensure that no metal parts, grinding dust, dust or other foreign bodies can enter the unit.

10.6 Water cooling for MIG/MAG welding torches

The FOCUS.ARC P/S or MEGA.ARC P/S Schweißanlagen with water cooling (-W / -WS) the torch is water-cooled.

The water level in the tank must be checked before commissioning. If the water level is lower than 3/4 of the tank capacity, the cooling water must be refilled. The special coolant "REHM - Coolant RCL" (order no. 1680075, 5 litres and 1680077, 25 litres) developed and tested by REHM is specified as the coolant. The cooling water level must be checked at regular intervals.

The FOCUS.ARC P is equipped with a flow monitor which issues an error message (see Section 13) if the water flow is too low.

10.7 Connecting the welding cables

The REHM welding units are equipped with quick-connect plugs and sockets for connecting the grounding cable. In order to achieve optimum welding results, ensure that all welding cable connections are tight and that the insulation is not damaged. The contact transition surfaces must be kept clean and free from tarnishing in order to avoid increased contact resistances, which cause distortions in the welding result and local overheating in the connections.

10.8 Connecting the torch

For the connection of the GMAW welding torch there is a special connection on the housing (Euro central connection), through which the connections for the welding current, the probe lines and the gas are made.

If water-cooled torches are used, the cooling water hoses are connected via quick couplings. These are colour-coded (red = return, blue = flow).



Important!

When using a gas-cooled torch on a water-cooled system, the water connections must be connected via a hose bridge or the water cooling must be set to "Off" in the Setup submenu so that the water pump is not damaged.

10.9 Inserting the wire

After inserting the wire on the coil mandrel, thread the wire manually through the guides to the feed rolls. Ensure that you use the appropriate drive rollers according to the wire diameter and wire type (solid). When the wire has been inserted into the guide of the torch hose set past the second drive roller, fold the pressure rollers onto the wire and fix them. Now thread the wire by pressing the pushbutton Threading (Fig. 4). Ensure that the torch runs as straight as possible without kinks in order to avoid complicating threading and to prevent the wire from buckling or damaging the wire liner.

11 Operation

11.1 Safety instructions

Carefully read the operating instructions, in particular the → **Section 2 Safety**, before commissioning and before beginning work with this welding current source.



Warning!

REHM welding equipment should be operated only by persons who are trained and instructed in the use, maintenance and the safety regulations concerning welding systems.

11.2 Checks before switching on

It is a requirement that

- the system is properly placed in accordance with → **Section 10 Commissioning**
- all connections (inert gas, torch connection) are properly made in accordance with → **Section 10, Commissioning**
- the scheduled periodic maintenance work has been performed in accordance with → **Section 13, Maintenance**
- the safety equipment and the system components (in particular the torch connection hoses) have been checked by the operator, are functional and ready for use
 - the operator and the assisting persons are wearing the appropriate protective clothing and the securing of the work area has been completed so that no uninvolved persons are placed in danger



11.3 Connecting the grounding cable

Warning!

Ensure that the welding current cannot flow through lifting device chains, crane cables or other electrical conductors.



Ensure that grounding cables are connected to the workpiece as close as possible to the welding site. Grounding cables that are connected to distant points reduce the effectiveness and increase the risk of electrical shock and vagrant currents.

11.4 Practical instructions for use

The following practical instructions for use can only provide an overview of the various applications of *REHM REHM FOCUS.ARC P/S* or *MEGA.ARC P/S* welding systems. If you have any questions about special welding tasks, materials, inert gases or welding equipment, please refer to the relevant technical literature or to the *REHM* specialist dealer.

Weldable materials	The <i>REHM</i> FOCUS.ARC P/S oder MEGA.ARC P/S inert gas welding systems can be used to weld a wide variety of materials, e.g. unalloyed and alloyed steels, stainless steels and aluminium.
Wire electrodes	Various different wire diameters and materials are offered and used for MIG/MAG welding. The diameter of the wire is based on the thickness of the base material and the required welding current. The wire electrode material is selected based on the base material and the desired quality of the weld seam. The most common materials and their respective specifications can be found in the relevant specialist literature.
Inert gas	<p>Mixed gas consisting of argon with a content of 18 % CO₂ is mainly used for welding steels.</p> <p>Mixed gas consisting of argon with a content of 2 % CO₂ is mainly used for welding stainless steels.</p> <p>Pure argon serves as inert gas for aluminium.</p> <p>The amount of inert gas required depends on the wire diameter, the gas nozzle size, the welding current height and the air movement at the workplace. The required gas quantity for mixed gases is approx. 7 ... 16 l/min, for argon at approx. 10 ... 18 l/min.</p> <p><i>General principle for the gas adjustment:</i></p> <p><i>For steel:</i> <i>Wire diameter x 10 = gas volume in litres</i></p> <p><i>For stainless steel:</i> <i>Wire diameter x 11 = gas volume in litres</i></p> <p><i>For Aluminium:</i> <i>Wire diameter x 12 = gas volume in litres</i></p>
MIG/MAG welding torch	The gas-cooled version of the GMAW welding torches recommended by REHM must be connected to the gas-cooled REHM systems, water-cooled torches to the water-cooled types.
Torch equipment	<p>The accessories for the torch depends on and must be matched to the particular welding task.</p> <p>Contact tips</p> <p>Contact tips are wear parts and must be replaced periodically. Care must be take to select contact tips of the correct size for the respective wire diameter.</p> <p>Special contact tips for different wire diameters are available for aluminium welding tasks, which can be found in the <i>REHM welding accessories catalogue</i>.</p> <p>Gas nozzles</p> <p>Gas nozzles in different versions can be found in the <i>REHM welding accessories catalogue</i>.</p>
Wire liner	<p>Wire liners must be selected to match the various different types of material and wire gauges. The range for this can be found in the <i>REHM welding accessories catalogue</i>.</p> <p>In addition, please refer to the instructions of the torch manufacturer (see operating instructions).</p>
Wire feed setting	<p>The following points must be observed in order to achieve safe wire feeding:</p> <p>Feed rollers must be selected to match the wire diameter.</p> <p>Precise speed control of the feed motor ensures a constant wire feed speed.</p> <p>Safe wire feeding is provided by the compact 4-roller system.</p> <p>Care must be taken to ensure that the pressure on the wire is set correctly via the feed rollers. With aluminium, the pressure should be as low as possible, but</p>

still allow the wire to be transported safely. In the case of steel and stainless steel, the pressure should be so strong that the wire coil can still be stopped manually while the drive is running.



ATTENTION: In the welding shop, the side wall that protects the wire feed area from access must be closed to avoid the risk of injury (e.g. crushing)!

The wire feed speed must be set so that a smooth and stable arc is produced. When increasing the welding energy, the wire feed speed increases automatically and can be easily corrected at the wire feed speed correction button if necessary.

Uncoiling mandrel setting

The brake of the uncoiling mandrel must be adjusted so that the wire does not uncoil when the wire feed is switched off at the welding end.

Welding current level

The power of the machine is adjusted via the welding energy rotary knob (and special parameters). The required welding power depends on the respective welding task.

Richtwerte für den Zusatzwerkstoffverbrauch sowie Schweißstrom und-spannung bei Drahtdurchmessern von 1,2mm für repräsentative Schweißaufgaben sind folgender Tabelle zu entnehmen:

Material	Thickness	Wire feed Speed	Welding current	Welding Voltage
	mm	m/min	A	V
Carbon Steel	2,0 - 4,0	3,1 – 4,6	125 - 169	19,5 – 21,0
Carbon Steel	8,0 – 12,0	8,0 – 9,8	254 - 296	29,4 – 30,9
Stainless Steel	2,0 - 4,0	3,6 – 8,5	122 - 252	15,7 – 25,0
Aluminum	2,0 - 4,0	6,8 – 11,6	104 - 189	14,8 – 21,3

12 Fault

12.1 Safety instructions



Warning!

If a fault occurs that represents a hazard to persons, systems and/or the environment, switch off the system immediately and secure against restarting.

Only restart operations with the system after the fault has been eliminated and no hazard exists for persons, machines and/or the environment.

Faults must only be eliminated by qualified persons under the observance of all safety instructions. → Section 2

Before restarting, the system must be approved by qualified personnel.

12.2 Table of faults

Control lamp TEMPERATURE on

Cause:

Permitted temperature in the power unit has been exceeded
 Maximum duty cycle exceeded
 Ambient temperature too high
 Contamination of the air inlet or air outlet
 Air inlet or air outlet covered
 Fan defective

Remedy:

Leave to cool, ensure free air circulation, clean the machine if necessary
 Allow system to cool down
 Provide cooling
 Cleaning, ensure free air supply
 Remove cover, ensure free air
Service required !

Welding current does not reach the set value or does not occur

Cause:

Grounding cable poorly connected or not connected at all
 Wrong characteristic curve selected

Remedy:

Check
 Select the appropriate characteristic curve for the filler material

No inert gas

<u>Cause:</u>	<u>Remedy:</u>
Bottle empty	Check
Pressure reducer defective	Check
Hose kinked	Check
Machine gas valve defective	<i>Service required !</i>

Arc sputters and jumps

<u>Cause:</u>	<u>Remedy:</u>
Contact tip worn	Replace contact tip
Feed rollers have incorrect diameter	Use feed rollers with correct diameter
Wire liner very dirty	Replace wire liner
Electrode and workpiece do not reach working temperature	Use thinner wire
Incorrect wire feed speed	Adjust speed

Arc has a strange colour

<u>Cause:</u>	<u>Remedy:</u>
Too little or no inert gas	Check inert gas supply
Incorrect inert gas	Use appropriate inert gas

Wire unwinds uncontrolled

<u>Cause:</u>	<u>Remedy:</u>
Wire coil brake is applied either too strongly or too weakly	Adjust wire coil brake
Wire feeding problems	Hose set should be blown out at each wire change. Wire liner and feed rollers must match the wire diameter.
Control defective	<i>Service required !</i>

Water-cooled torch gets too hot

<u>Cause:</u>	<u>Remedy:</u>
Water hoses kinked	Check water hoses for correct position
Too little or no cooling water in the tank	Check cooling water level
Water pump defective	<i>Service required !</i>

12.3 Error messages

Error number	Error	Cause	Elimination
1 000	Mains undervoltage	Mains voltage is below the tolerance range	Switch the unit off and check the mains voltage
2 000	Mains overvoltage	Mains voltage is above the tolerance range	Switch the unit off and check the mains voltage
22 000 to 22 009	Communication error control/power section	The bus communication between controller and power section is faulty	Switch the current source off and on again. If the error occurs again → Contact service
23 000 to 23 243	Communication error current source	Bus current source communication is faulty	Switch the current source off and on again. If the error occurs again → Contact service
30 000 to 30 400	Data record Welding characteristic curves	Data record for welding characteristic curves is not available or not compatible	Switch the current source off and on again. If the error occurs again → Contact service
35 000	Data record Job	Data record for Job is not available or not compatible	Load job again. If the error occurs again → Contact service
40 000 to 42 105	Permitted temperature in the power unit exceeded	Permitted temperature in the power unit has been exceeded	Allow the current source to cool down
71 000	Coolant flow	<ul style="list-style-type: none"> Coolant monitor detects low coolant flow Coolant monitor blocked by dirt 	<ul style="list-style-type: none"> Immediately switch off the current source Check that the connecting cable is plugged in Check the coolant level Check the connections on the water cooled torch Eliminate interruptions in the coolant circuit Bleed the coolant circuit Check the pump
77 000 to 77 001	Coolant excess temperature	Temperature of the coolant is too high	<ul style="list-style-type: none"> Let the water cooler cool down Top-up coolant
80 000 to 80 003	Wire feed Motor current	The current consumption of the wire feed motor is too high	<ul style="list-style-type: none"> Wire feeding does not run cleanly DV motor is defective
> 100 000	Service call	An analysis of the cause can be made by the service technician	Contact service

13 Maintenance and repair

13.1 Safety instructions



Warning!

Maintenance and repair work may only be performed by persons who have been trained by REHM. Please contact your REHM dealer. When replacing parts only use REHM original spare parts.

If maintenance or repair work is performed on this unit by persons who have not been trained and authorised to carry out the work by REHM, then claims against REHM become void.

Before beginning cleaning work the unit must be switched off and disconnected from the mains supply.

Before maintenance work the welding system must be switched off and disconnected from the mains supply and secured against unintended reconnection.

Supply lines must be shut off and vented free of pressure.

The warning notices listed in → Section 2 “Safety” must be observed.

The welding system and its components must be maintained in accordance with the requirements of the maintenance table.

Insufficient or improper maintenance or repair may result in operating faults. Periodic maintenance of the system is therefore essential. No constructive change or additions may be made to the system.

13.2 Maintenance table

The maintenance intervals are recommended by REHM for standard requirements (for example, single shift operation, use in a clean and dry environment). The precise maintenance intervals are specified by your safety officer.

Activity	Section	Interval
Cleaning the inside of the unit	14.3	min 2 x per year
Checking cooling water and the cooler	14.4	Daily
Functional test of the safety equipment by operating personnel		Daily
Visual system check, particularly the connection cables and torch hoses		Daily
Have the connecting lines and torch hoses checked by qualified personnel; log the checks in the logbook provided. Perform checks more regularly depending on the country-specific laws.		Every six months
Have the complete welding system checked by qualified personnel; log the checks in the logbook provided. Perform checks more regularly depending on the country-specific laws.		Annually

13.3 Cleaning the inside of the unit

If the *REHM* welding unit is used in a dusty environment the inside of the unit must be cleaned at regular intervals by blowing out or vacuuming.

The frequency of this cleaning depends on the respective conditions of use, however, it should be carried out at least twice a year. Only use clean, dry air to blow out the unit or use a vacuum cleaner.

13.4 Cooling water check

The water level in the tank must be checked daily on machines with built-in water recirculation cooling.

If the water level is lower than 3/4 of the tank capacity, the cooling water must be refilled. The special coolant "REHM - Coolant" (order no. 1680075, 5 litres and 1680077, 25 litres) developed and tested by *REHM* is specified as the coolant.

As part of this check, the degree of contamination in the cooling water should also be checked. To ensure the proper torch cooling the cooler should be cleaned by blowing out or sucking out.

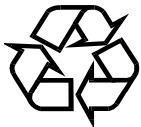

Coolants are hazardous to the environment; they must not be drained into the sewage system.

Dispose of these agents at appropriate collection points for hazardous substances.

If maintenance or repair work is performed on this unit by persons who have not been trained and authorised to carry out the work by *REHM*, then and claims against *REHM* become void.

13.5 Proper disposal



Only for EU countries!

Do not dispose of electric appliances in domestic waste!

In accordance with the European Directive 2002/96/EC concerning old electrical and electronic devices and its transposition into national law, used electrical appliances must be collected separately and recycled in an environmentally friendly manner.

14 Circuit diagrams

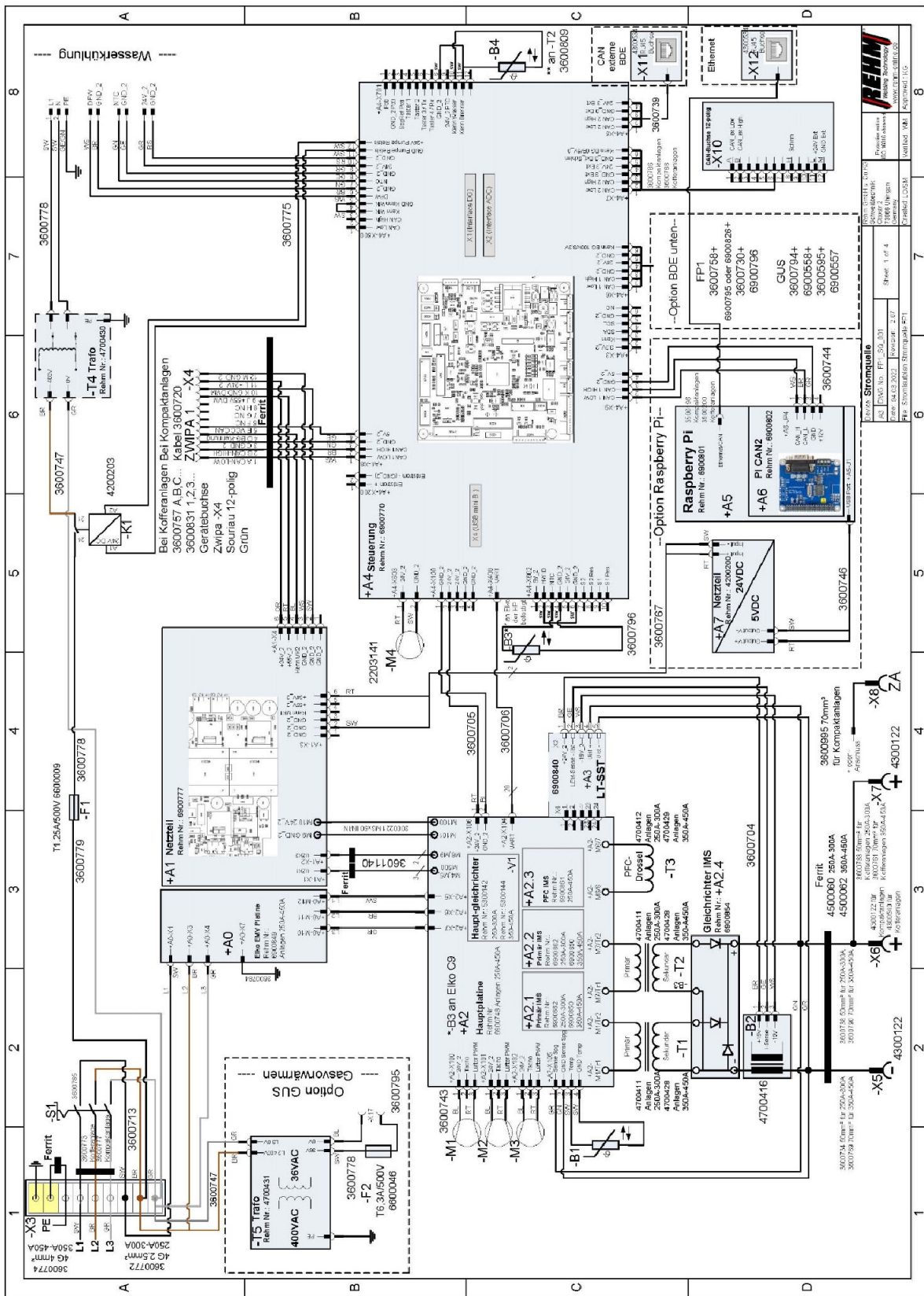
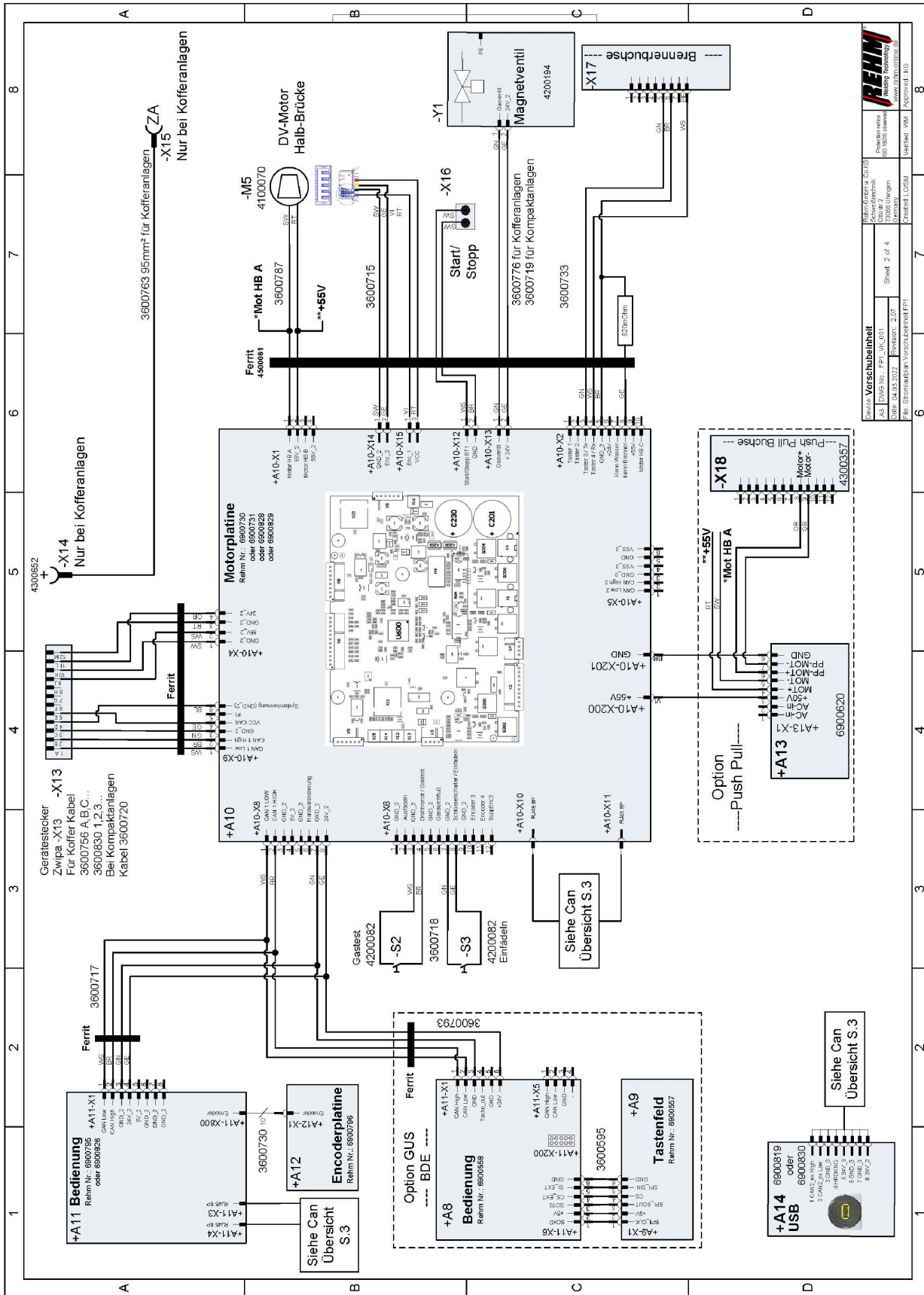

Figure 10: FOCUS.ARC P current source



REHM
Welding Technology

Rehm GmbH, Götting
Göttinger Str. 2
37086 Utingen
Tel: +49 531 2300-0
Fax: +49 531 2300-230
E-Mail: rehm@rehm.de

Rehm-Vorschubmittel
AS 2/MS No. PFI 0/1/0/1
Sheet 2 of 4
Date: 04.03.2022, Revision: 2/07
File: Stromplan_Vorschubmittel/FPI

Projektname
Gestell
Credat LOGM
Verfasser: VM
Geprüft: LGS

Figure11: FOCUS.ARC P wire feed case

14.1 Characteristic curve current source

Pos	Name	Part*	Comments	Item number
+ A0	ELKO EMV circuit board	E	250A-450A	690 0849
+ A1	Power supply	E	-	690 0777
+ A2	Main board	E	250A-300A 350A-450A	690 0747 690 0748
+ A2.1/A2.2	Primary IMS	E	250A-300A 350A-450A	690 0852 690 0850
+ A2.3	PFC IMS	E	250A-450A	690 0861
+ A2.4	Rectifier IMS	E	-	690 0854
+ A3	Power section - control	E	250A-300A 350A-450A	220 3113 220 3114
+ A4	Control (process card)	E	250A-300A 350A-450A KRAFT.MIG	220 3157 220 3159 220 3155
+ A5	Raspberry-PI-3	E	-	690 0801
+ A6	PI CAN2	E	-	690 0802
+ A7	Power supply	E	24VDC_5VDC_3A	420 0200
+ A8/+ A11	M2 BDE	E	FP1 KRAFT.MIG	690 0795 690 0558
-	Complete controls 7 inch	E	FP1	210 2289
+ A9	Keypad	E	KRAFT.MIG	690 0557
+ A10	Motor card	E	-	690 0730
+ A12	Encoder circuit board	E	FP1	690 0796
+ A13	Push-Pull circuit board	E	-	690 0620
- B1	Temperature sensor	E	-	360 0704
- B2	Current converter	E	-	470 0416
- B3	Temperature sensor	E	-	360 0796
- B4	Temperature sensor	E	-	360 0809
- B5	Flow monitor	E	DB/0,5l 6mm	360 0781
- B6	Temperature sensor	E	-	360 0782
- F1	T 1, 25A / 500V	E	-	660 0009
- K1	Relay	E	24V/DC	420 0203
- M1/M2/M3	Fan 80x80x38mm	V	24V/DC	410 0055
- M4	Fan 80x80x25mm Extension	V	24V/DC	220 3141
- M5	Wire feed motor	V	-	410 0070

Pos	Name	Part*	Comments	Item number
- M6	Water pump	V	230V/AC	410 0027
- M7/M8/M9	Fan Ø 120mm	V	230V/AC	410 0007
- S1	Main switch	E	-	420 0096
- S2/S3	Button "Gas" / "Wire feed"	E	-	420 0082
- T1/T2	Transformer	E	250A-300A 350A-450A	470 0411 470 0428
- T3	PFC choke	E	250A-300A 350A-450A	470 0412 470 0429
- T4	Autotransformer (water-cooled)	E	-	470 0430
- T5	Transformer	E	KRAFT.MIG	470 0431
- V1	Main rectifier	E	250A-300A 350A-450A	530 0142 530 0144
- X4	Device socket ZWIPA	E	Case systems	360 0757
- X5	Mounting socket Ground (workpiece)	E	-	430 0122
- X6	Mounting socket plus	E	With cover Without cover	430 0540 430 0122
- X7/X14	Mounting socket plus for ZWIPA	E	-	430 0122
- X8/X15	Welding torch central connection	E	ZA	750 4017
- X8/X15	ZA housing	E	ZA	260 0410
- X10	CAN socket 12 pin	E	Compact system Case	360 0786 360 0788
- X11	CAN externe BDE	E	-	430 0534
- X12	Ethernet	E	-	430 0534
- X13	Device socket ZWIPA	E	Case	360 0756
- X17	Torch socket 7 pin	E	-	360 0733
- X18	Push-Pull socket 12 pin	E	-	430 0357
- Y1	magnetic valve	E		420 0194

* E = spare part; V= wear part

15 Components and spare parts

15.1 Characteristic curve wire feeding unit

Wire feeding unit REHM Item no. 4000194:

Pos.	Name	Part *	Comments	Item number
1	Wire infeed nipple - SET blue (Series)	V	Plastic/ Ø0.6-1.6	2600400
2	Solid wire feed rolls	V	Ø 0.6/0.8	7503054
		V	Ø 0.8/1.0	7503055
		V	Ø 0.9/1.1	7503065
		V	Ø 1.0/1.2	7503053
		V	Ø 1.2/1.6	7503056
		Core wire feed rolls	V	Ø 1.2/1.6
3	Capillary tube up to 1.6 mm ø wire electrode	E	Ms	7503067
4	Protective tube for Teflon core up to 4 mm outside diameter	E	Ms	7503068
5	Counter pressure roller for ST4 drive	V	-	7503090

* E = spare part; V= wear part

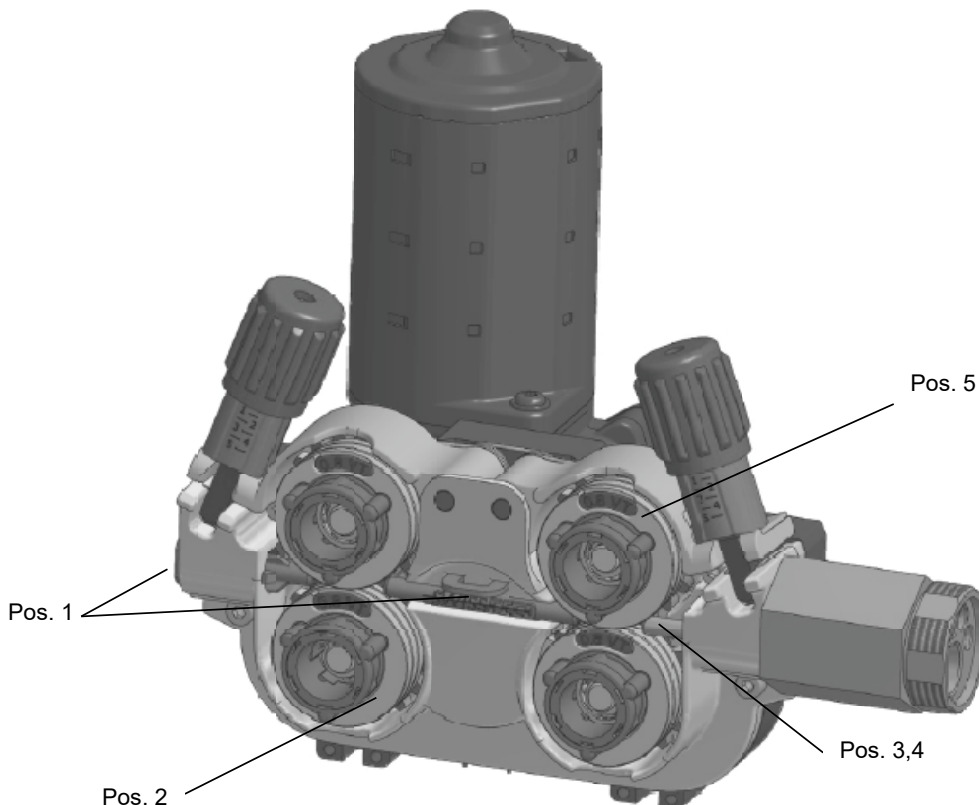

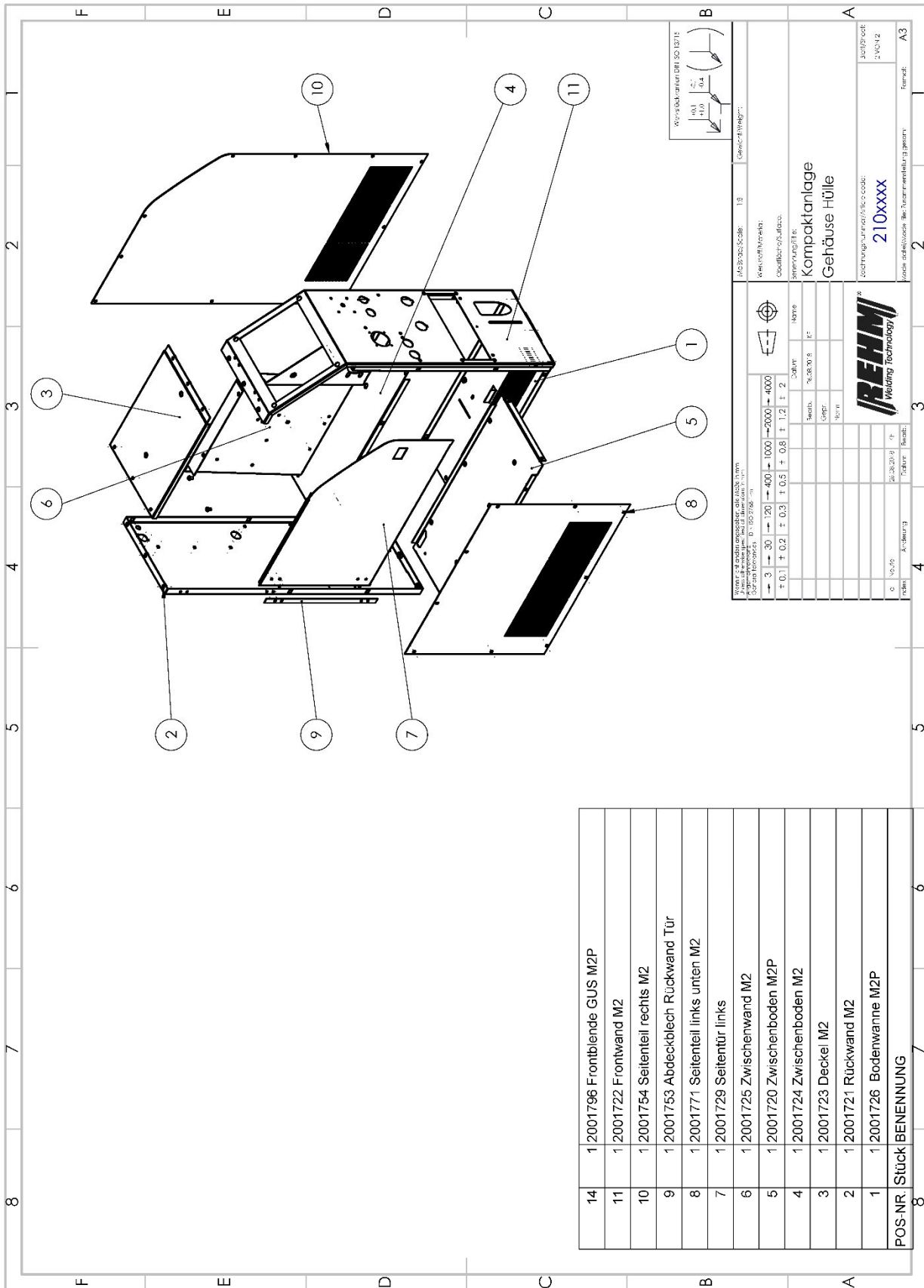

14	1	2001796	Frontblende	GUS M2P
11	1	2001722	Frontwand	M2
10	1	2001754	Seitenteil	rechts M2
9	1	2001753	Abdeckblech	Rückwand Tür
8	1	2001771	Seitenteil	links unten M2
7	1	2001729	Seitenteil	links
6	1	2001725	Zwischenwand	M2
5	1	2001720	Zwischenboden	M2P
4	1	2001724	Zwischenboden	M2
3	1	2001723	Deckel	M2
2	1	2001721	Rückwand	M2
1	1	2001726	Bodenwanne	M2P
POS-NR.	Stück	BENENNUNG		

Verstärkungen DIN ISO 12175
 $\begin{matrix} +0.1 & 0.1 \\ +1.0 & 0.4 \end{matrix}$

3	4	5	6	7	8	9	10	11	12	13	14	15	16	17	18	19	20	21	22	23	24	25	26
---	---	---	---	---	---	---	----	----	----	----	----	----	----	----	----	----	----	----	----	----	----	----	----

29	1	7302580	Auflieber KRAFT, MIG Front
26	2	2500100	Griff Kunststoffdesign (RAL 9022)
18	1	7302451	Grafikfolie 7 Zoll M2
17	1	2600397	Seitenblende rechts M2
16	1	2600196	KOFFERHUELSE
15	1	2600396	Seitenblende links M2
14	4	3300006	Gummi-Metall-Puffer 20x15 1xM6x12a SH 60
13	1	2600207	Griff Koffer InvPro RAL 9022
12	1	2001750	Frontwand VK M2
9	1	2001757	Abdeckblech Rückwand Tur Koffer VK M2
8	1	2001780	Seitentür links VK M2
7	1	2001779	Seitenstück rechts VK M2
6	1	2001777	Anschlussblech VK M2
5	1	2001776	Zwischenwand VK M2
4	1	2001775	Deckel VK M2
3	1	2001759	Rückwand VK M2
1	1	2001774	Bodenwanne VK M2
POS NR.	Gehäuse/MENGE BENENNUNG		

Materialcode:	15	Gewicht/Weight:	
Werkstoff/Alu-Bezeichnung:		Combustion/Alu-Bezeichnung:	
Vorschubkoffer FOCUS.ARC wassergekühlt			
Zeichnungsnummer/Article code: 730XXXX			
Modultitel/Module title: 7302580 Vorschubkoffer FOCUS.ARC wassergekühlt			
Blattanzahl: 1 von 1			

Name: 7302580 Vorschubkoffer FOCUS.ARC wassergekühlt Zeichnungsnummer: 7302580 Datum: 01.10.2018 Bearb.: EF Gepr.: EF Name:	Datum: 01.10.2018 Bearb.: EF Gepr.: EF Name:
d: Neuill d: 01.10.2018 d: EF	d: 01.10.2018 d: EF d: EF
d: Änderung d:	d:

REHM
Welding Technology

16 Technical data

Type overview

Technical data		FOCUS.ARC P Series MEGA.ARC P and S Series			
Power class		300	350	400	450
Setting range	[A]	20-300	20-350	20-400	20-450
Duty cycle (ED) at I _{max} . (40°C)	[%]	80	80	80	60
Weld current at 100 % ED	[A]	280	320	370	430
Idle voltage, approx.	[V]	89	89	75	75
Mains connection	[V]	3x400	3x400	3x400	3x400
Mains voltage tolerance	[%]	+15/-25	+15/-25	+15/-25	+15/-25
Power consumption at I _{max}	[kVA]	11	13.7	16,8	20.6
Power factor λ	[cos phi]	0,95	0,95	0,95	0,95
Fuse (slow-blow)	[A]	32	32	32	32
Protection type	[IP]	23	23	23	23
Compact gas cooled	[kg]	46	49	49	49
Compact water cooled (W)	[kg]	56	59	59	59
With separate wire feed case Gas cooled (S)	[kg]	57	60	60	60
With separate wire feed case Water cooled (WS)	[kg]	70	73	73	73
Dimensions without trolley (LxWxH)					
Compact gas cooled	[mm]	650x330x624			
Compact water cooled (W)	[mm]	650x330x820			
With separate wire feed case Gas cooled (S)	[mm]	650x330x1100			
With separate wire feed case Water cooled (WS)	[mm]	650x330x1100			
Dimensions with trolley (LxWxH)					
Compact gas cooled	[mm]	1000x560x780			
Compact water cooled (W)	[mm]	1000x560x1000			
With separate wire feed case Gas cooled (S)	[mm]	1000x560x1300			
With separate wire feed case Water cooled (WS)	[mm]	1000x560x1300			

Subject to technical changes through further development.

- a) Power factor λ = describes the degree of efficiency Efficiency on to Efficiency off, cos generally describes the ratio of active power to apparent power
- b) Degree of protection = Extent of protection provided by the enclosure against ingress of solid foreign bodies and water (IP23 = protection against solid foreign bodies > 12.0 mm \varnothing and against water spray 60° from above)

17 INDEX

Intended Qualification	8 12
A	
and health Applications	11 11
C	
Changes to the system	12
Checking cooling water and the cooler	66
Checks before switching on	58
Cleaning the inside of the unit	65
Commissioning	55
Connect grounding cable	58
Connecting the grounding cable	58
Connecting the welding unit	56
Contact tips	59
Cooling the welding unit	56
E	
Electrodes	59
F	
Fault	61, 64
Function description	18
G	
Gas nozzles	59
I	
Increased electrical hazard	55
Inert gases	59
Instructions for use	59
M	
Machine name	2
Maintenance	64
Manufacturer	2
MIG/MAG welding torch	59
Water cooling	56
O	
Occupational safety	11
Operating mode	24
Operation	58
Checks before switching on	58
Safety information	58
P	
Product identification	
Machine name	2
Type number	2
Proper disposal	66
Purpose of the document	12
R	
Residual dangers	11

Index

S**Safety**

Hazards of non-compliance 11

Safety information 6, 10, 11

Operation 58

Safety instructions

Safety symbols 6

Safety symbols 6

Storing the operating instructions 12

Symbols 9

T

Table of faults 61

Technical data 77

Threading 49

Torch accessories 59

Type number 2

Typographic distinctions 9

U

Uncoiling mandrel setting 60

W

Warning symbols on the system 10

Warnings and symbols

Presentation 10

Water cooling for MIG/MAG welding torches 56

Weldable materials 59

Wire electrodes 59

Wire liner 60

Working under elevated electrical risk 55



EC declaration of conformity

For the following named products

MIG/MAG impulse welding systems

FOCUS.ARC P	250
FOCUS.ARC P	300
FOCUS.ARC P	350
FOCUS.ARC P	400
FOCUS.ARC P	450

it is hereby confirmed that they comply with the essential protection requirements which are laid down in the Directive **2004/108/EU** (EMC Directive) of the council on the approximation of the laws of the Member States relating to electromagnetic compatibility and in the Directive **2006/95/EU** relating to electrical equipment designed for use within certain voltage limits.

The above products comply with the requirements of this directive and comply with the safety requirements for arc welding units in accordance with the following product standards:

EN 60 974-1: 2006-07

Arc welding equipment - Part 1: Welding current source

EN 60 974-2: 2003-09

Arc welding equipment - Part 2: Liquid cooling systems

EN 60 974-5: 2003-02

Arc welding equipment - Part 5: Wire feed device

EN 60974-10: 2004-01

Arc welding equipment - Part 10: Electromagnetic compatibility (EMC) requirements

according to the EC. Directive **2006/42/EC** article 1, paragraph 2 the above mentioned products fall exclusively within the scope of the directive **2006/95/EC** relating to electrical equipment designed for use within certain voltage limits.

This declaration is given for the manufacturer:

REHM GmbH u. Co. KG Schweißtechnik
Ottostr. 2
73066 Uhingen

Uhingen, 18/02/2019

submitted by

R. Stumpp

Managing Director

Rehm GmbH u. Co. KG Schweißtechnik
Ottostraße 2 | 73066 Uhingen | Germany

Tel.: +49 (0) 7161 3007-0
Fax: +49 (0) 7161 3007-20

E-Mail: rehm@rehm-online.de
Internet: www.rehm-online.de